



Focus505 SERIES
CHIAYO

Portable Sound System
OPERATION MANUAL



GREEN PRODUCT
It has been RoHS Compliant

IC : 3563A-FOCUS505

IC : 3563A-SQ5016

IC : 3563A-SM5016



CHIAYO ELECTRONICS CO., LTD.

<http://www.chiayo.com.tw> E-mail: sales@chiayo.com.tw

OFFICE: 30, LANE 27, SEC.4, JEN-AL ROAD, TAIPEI, TAIWAN / TEL: 886-2-2741-5741 FAX: 886-2-2752-5242

FACTORY: 88, CHUNG HSIAO STREET 2, CHIAYI, TAIWAN. / TEL: 886-5-271-1000 FAX: 886-5-276-7611

Printed in Taiwan, April 2008

FC CE C 1211146

CHIAYO ELECTRONICS CO.,LTD

Focus 505 Operation Manual

Congratulation and thank you for the purchase of this all-in-one ultra compact portable sound system. To ensure a trouble-free operation, please read this manual thoroughly and fully understand its controls and functions.

There are various versions of the Focus 505 as follow :

1. Focus 505 Passive Speaker. (Fig.1)
2. Focus 505 Active Speaker. (Fig.2)
3. Focus 505 with Amplifier. (Fig.3)
4. Focus 505 with CD / USB Player. (Fig.4)
5. Focus 505 with CD / USB Player & Digital Recorder. (Fig.5)
6. Focus 505 with Digital Recorder.(Fig.6)

All the versions can be equipped with 1 or 2 Wireless (WR) receiver module(s). The wireless (WR) receiver module can be either VHF or UHF. The VHF module is a fixed crystal single frequency type whereas the UHF module is a PLL synthesized type with 16 preset frequencies (identified by external 16 channel rotary switch(s)).

Remark: It is also possible to have all the above versions without any wireless (WR) fitted.

Configuration :

All versions of Focus 505 series comes equipped with the following :

- 1.A switch mode power supply.
- 2.One or two wireless microphones, either handheld or bodypack transmitter. (except version with no built-in wireless receiver module).

Matching Transmitters

| Transmitter types | Handheld | | Beltpack | | Handheld | Beltpack | Handheld | Beltpack |
|-------------------|----------|------------------|----------|------------------|------------------|------------------|----------|----------|
| Frequency band | UHF | | | | VHF | | | |
| Transmitters | SQ-5016 | SQ-816 SQ-916 | SM-5016 | SM-816 SM-916 | SQ-216 SQ-316 | SM-216 SM-316 | Q-1002 | M-1002 |
| Battery used | AAx2 | AAx3 9Vx1 | AAx2 | AAx3 9Vx1 | AAx3 9Vx1 | AAx3 9Vx1 | 9Vx1 | 9Vx1 |
| No. of channel | 16 | | | | | | 1 | |

Optional accessories :

- 1.Carrying bag.
- 2.Tripod stand.
- 3.Charger for UHF transmitter.
- 4.Focus 505 active speaker / passive speaker
- 5.Wired microphone.

Remark: Manufacturer reserves the rights to change the above combinations without prior notice.

Maintenance-free Lead Acid battery

Guidelines for maintenance-free Batteries:

1. Battery should operate at temperatures between 15°C ~ 50°C. To ensure a longer life span, it should be kept between 5°C ~ 35°C. For optimum result, 20°C ~ 25°C will be ideal. When temperature falls 15 degrees below zero, battery will undergo some changes in its chemical contents and therefore cannot be recharged. Operating the battery at higher temperature will result in higher capacity but shorter lifespan, whereas lower temperatures operation has a longer lifespan but less capacity.
2. If the battery is not recharged 72 hrs after it is completely used, it will be permanently damaged.
3. When the battery is being charged, the internal gases will be electrolyzed into water at the negative charge, maintaining the battery's storage abilities with no water added. However, erosion at the charged ends of the battery will cause poor performance.
4. The battery's cycle lifespan (no. of charge and discharge cycle) is determined by the degree at which power is dissipated., especially the degree of discharged each time it is used and the recovery charging method. For normal use, the battery can be used for longer hours when less power is dissipated each time and vice versa. At 25°C, maintenance-free batteries could be charged 150 ~ 200 times at 100% discharge each time.
5. Decrease in capacity, internal short circuit, deformation in appearance, erosion of charged ends and decrease in open circuit voltage are symbols indicating battery is approaching the end of its life cycle.
6. When two batteries are used in parallel connection, the resistance of the cables should be kept equal.

Properties of the Lead Acid Battery:

1. Has no memory effect. Can be charged at anytime, even when the recharge indication light is not on.
2. Performance and efficiency are affected by changes in the environment, especially temperature and humidity. (Best operated between 20°C ~ 25°C)
3. Battery discharge naturally according to a certain pattern even not in use. For best performance and a prolonged lifespan, it should be recharged every month even when not in use.
4. Under normal circumstances, battery could last for about a year.
5. When the battery's life expires, possible indicators include internal short-circuit, decrease in capacity, deformation in appearance, erosion of charged ends and decrease in operating voltage.

User's Precautions:

1. For first-time use, charge the battery for 10 hrs until it is fully charged.
2. To maintain performance and lifespan, if product has not been used for 3 months after the initial shipment, please fully charge the battery.
3. Before each use, it's advisable to charge the battery to its full capacity.
4. The average lifespan of the battery is one year. The user is advised to change the battery after one year of use.
5. The current consumption is in direct ratio with load current. The more current consumption, the less the operation time.

Remark:

The removal of the battery/ies must be done by an experienced qualified technician or by the appropriate recycling operator!

Caution and tips on how to obtain the best results.

1. Before inserting the batteries, please make sure that they are inserted according to the correct polarity.
2. The audio cable of VHF transmitters also serves as antenna. The length of the cable is cut according to the specific frequency range. Do not alter the length or mix around the cable of different transmitters. The use of wrong audio cable will affect the antenna efficiency of the transmitter!
3. Use only brand new Alkaline batteries. Do not use "general purpose" batteries, When batteries are weak, replace all the batteries at the same time. Do not mix and use new and old batteries together.
4. Position the receiver such that it has the least possible obstructions between it and the transmitter. Line of sight is best!
5. The transmitter and the receiver should be as close as possible but not less than 1m.
6. A receiver cannot receive signals from two or more transmitters simultaneously.
7. Turn the transmitter off when it is not in use. Remove the batteries if it is not to be used for a period of time.
8. Antennas form an integral part of the receiver and must be installed when in operation.

Simple DIY Trouble-shooting :

No sound when one speaks to the wireless microphone

Please verify the followings:

1. Main power switch of the system should be ON. When power on LED not lighting up, it means that the battery is either weak or not charged. Please plug in the AC cable to charge the battery. The rechargeable battery has a life span of about 2 years. If the batteries have reached their life expectancy, please change to a fresh pair.
2. The power switch of the corresponding receiver module should be put to ON. This is indicated by the lighted power LED. When two wireless microphones are used, both power switches of the receiver modules must be ON.
3. Wireless microphone should be switched to ON and verify that the battery is okay. (please refer to wireless microphone operating manual).
4. Please verify that the frequency on the wireless microphone and the corresponding built-in wireless receiver module are exactly the same frequency group and channel.
5. Master volume control of the system should be turned on.

No sound when " CD / USB Player " is used

1. Main power switch should be ON. When no light appears, it means that the battery is weak. Please plug in the AC cable to charge the battery.
2. CD volume control is turned on but Master volume control is not turned on.

Focus 505 Active Speaker

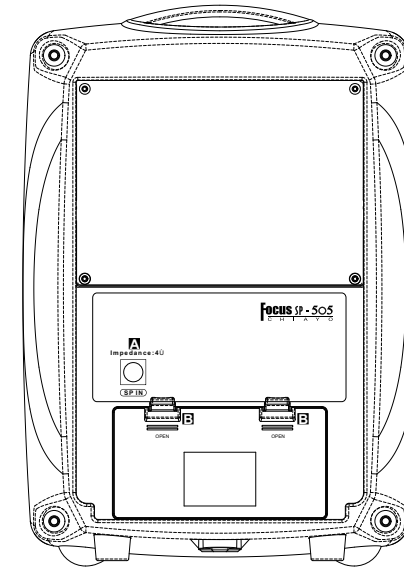

- A SP IN
- B Battery Compartment cover release button

Fig. 1

Focus 505 Passive Speaker

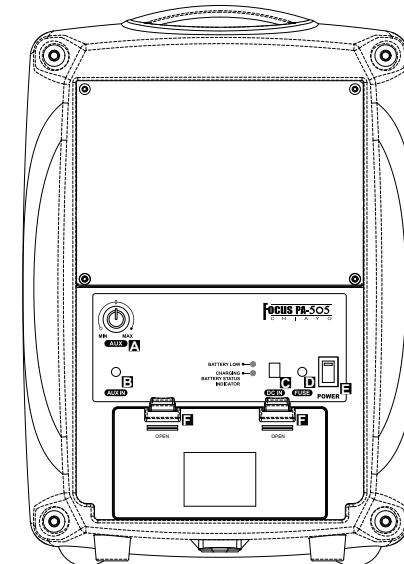

- A AUX volume
- B AUX IN
- C DC IN
- D FUSE
- E POWER
- F Battery Compartment cover release button

Fig. 2

Focus 505 (Amplifier version)

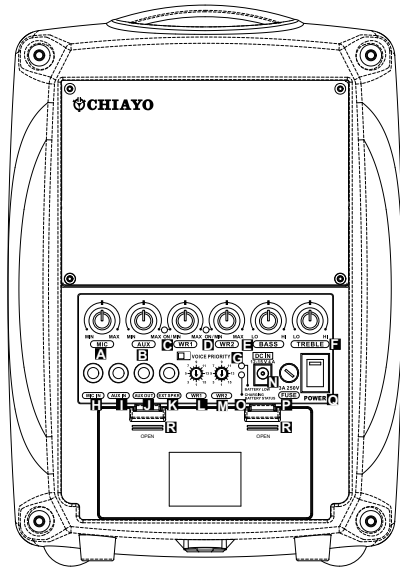

- Ⓜ MIC
- Ⓜ AUX
- Ⓜ WR1
- Ⓜ WR2
- Ⓜ BASS
- Ⓜ TREBLE
- Ⓜ VOICE PRIORITY
- Ⓜ MIC IN
- Ⓜ AUX IN
- Ⓜ AUX OUT
- Ⓜ EXT SPKR
- Ⓜ WR1 channel selector (UHF version only)
- Ⓜ WR2 channel selector (UHF version only)
- Ⓜ DC IN
- Ⓜ CHARGING indicator
- Ⓜ BATTERY LOW indicator
- Ⓜ FUSE
- Ⓜ POWER
- Ⓜ Battery Compartment cover release button

Fig. 3

Focus 505 (CD / USB Player version)

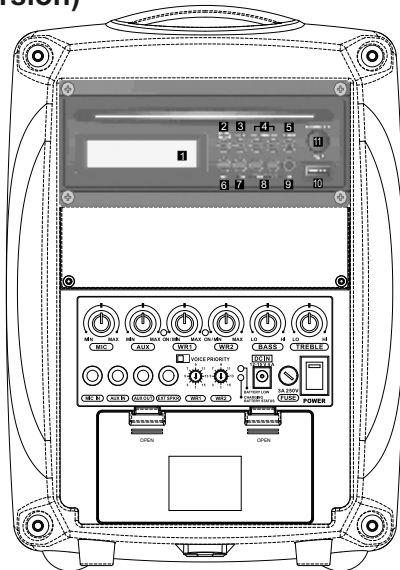

- Ⓜ LCD Display
- Ⓜ PLAY/PAUSE
- Ⓜ STOP
- Ⓜ SKIP
- Ⓜ EJECT
- Ⓜ CD SELECTOR
- Ⓜ USB SELECTOR
- Ⓜ FOLDER SKIP
- Ⓜ IR LED
- Ⓜ USB INPUT
- Ⓜ POWER/VOL.



Fig. 4

VHF Beltpack Transmitter M-1002 Parts & Functions

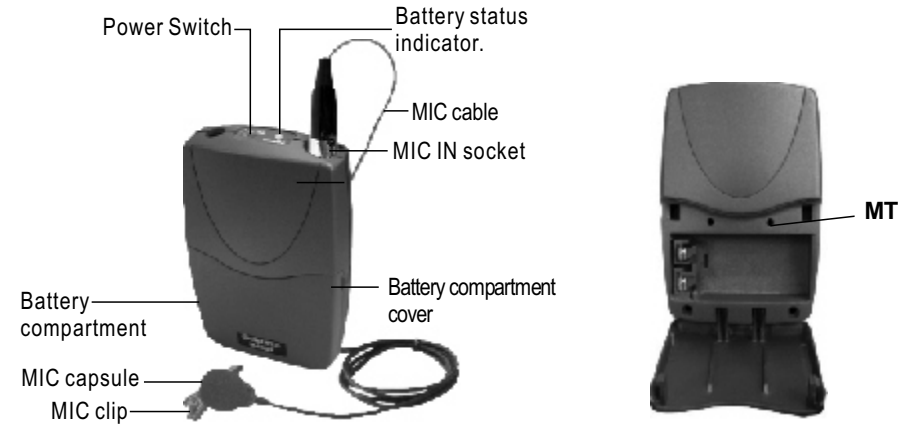

Input level Gain control adjustment

Low-impedance "MT" gain control is situated inside the beltpack transmitter. Gain control port is an adjustable design that enables user to use microphones of different output levels. To adjust the audio input levels, simply use a small screw driver to switch the "MT" control till a desired level is chosen.

Battery Installation

M-1002 uses 1 piece of 9V battery. To install new or replace the old battery, first open the battery compartment cover, then insert the new battery according to its correct polarity as indicated. For longer operation hour, Alkaline battery is recommended!

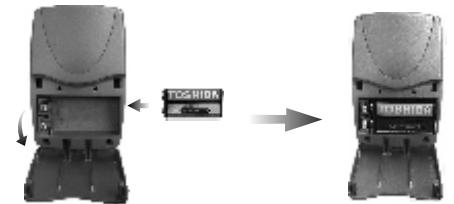

Belt Clip

This uniquely designed belt clip allows 360° rotation. Select the best position to achieve optimum wearing comfort.



Beltpack Transmitter SM-816(UHF) / SM-216(VHF)

Battery installation

This transmitter uses 3 pieces of "AA" size batteries (Alkaline battery is recommended). To install or remove the batteries, press the release buttons at the edges of the transmitter to open or close the cover as illustrated (Fig.1).

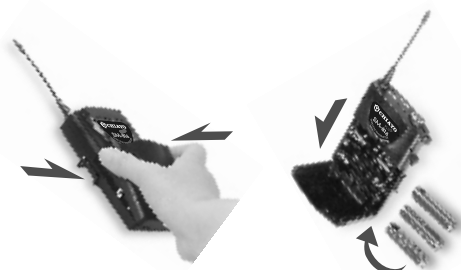

Fig.1

Beltclip installation

This specially designed detachable beltclip allows the user to wear the transmitter with antenna pointing upward or downward as illustrated. To wear the transmitter with the transmitter pointing upward, install the belt-clip as in Fig.2. To wear the transmitter with the antenna pointing downward, please install the belt-clip as in Fig.3.



Fig.2

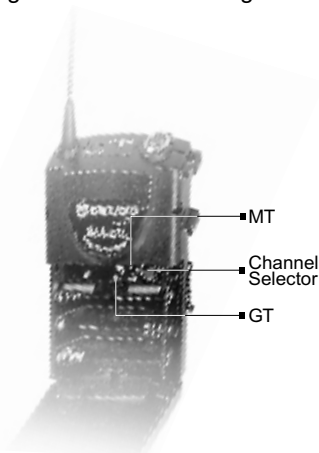

Fig.3

Channel selection and gain adjust

Channel selector and gain adjust are hidden in the designated cover of the front as illustrated.

To make channel selection and gain adjust, please press the designated cover and flip it open as illustrated. Channel selection can be made by rotating the selector with a small screw driver.



Gain adjust for Lavalier and Headset microphones can be done by adjusting the MT switch, whereas GT switch is for the gain adjust of electric Guitar and other high-impedance line level inputs.

Focus 505 (CD / USB Player & Digital Recorder version)

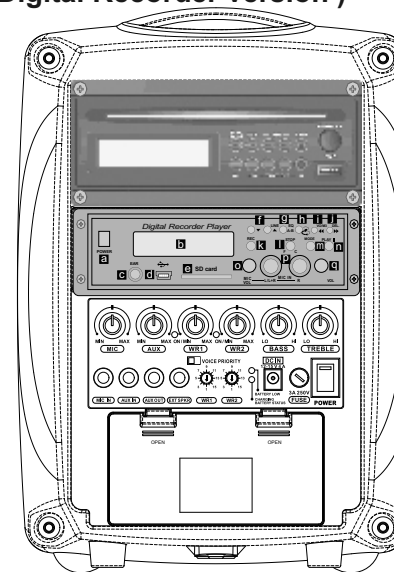

- POWER
- LCD Display
- EAR
- USB
- SD Card Slot
- LINE ▲▼
- EQ
- REPEAT
- STOP
- REC.
- MODE
- PLAY II
- MIC VOL
- VOL

Fig. 5

Focus-505 (Digital Recorder version)

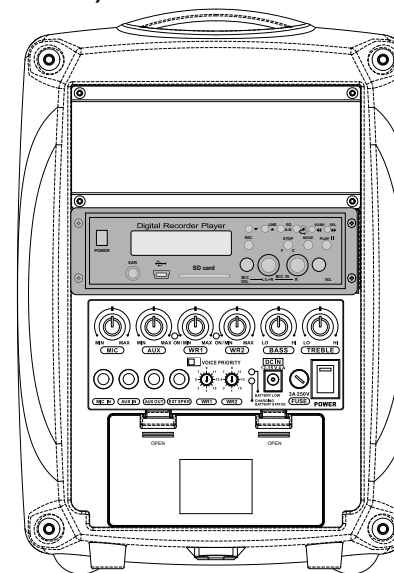

Fig. 6

Operating procedures

After unpacking the unit for the first time, please charge the unit for about 4~5 hours before any operation. This is absolutely necessary as the built-in rechargeable battery might have been discharged naturally due to long shipment and storage time, even though it has been fully charged in the factory prior to shipment.

To charge the battery, just plug in the DC end of the switch mode power supply into the DC IN of the unit and charging will start automatically. During the charging process, the charging indicator LED will flash RED. When GREEN LED stays glowing permanently, battery is then fully charged and normal operation could now be started.

To operate this portable sound unit, switch on the main POWER, which will glow GREEN. However, the main POWER switch does NOT switch on the WR module, CD / USB player and Digital Recorder as each of them has a dedicated Power / Volume control switch indicated by WR1, WR2. CD/USB Player and Digital Recorder have separate power switch on its panel.

When the Charging / Battery Status Indicator glows RED, it means the built-in rechargeable battery is weak and a recharge is necessary. While charging, the unit could also be operated simultaneously.

Operating the built-in Wireless (WR) receiver modules

On the Focus 505 control panel, there are two designated power switch / volume control knob for the built-in Wireless Receiver (WR). They are indicated by WR1 and WR2 .

To use the 1st wireless microphone, switch on the WR1 power cum volume control switch, Red LED next to it will glow. Switch on the corresponding transmitter (RF). Rotate the volume control knob clockwise and amplified sound could be heard if voice is spoken into the transmitter.

To use the 2nd wireless microphone, switch on WR2 power cum volume control switch and repeat the same operation as above.

By default, when the system is equipped with one WR receiver module only, it is always control via WR1 switch, WR2 is then redundant.

For Focus 505 which comes with wireless receiver (WR) module, there are two possibilities, namely the VHF or UHF version. The VHF receiver module is a fixed frequency type. To operate the VHF version, just switch on the corresponding wireless microphone(s) after switching on the WR1 or WR2 switch.

To operate the UHF version, which comes with 16 preset frequencies, please ensure that the channel setting on the wireless microphone and Focus 505 receiver module are the same before operation. Then perform the same procedure as above.

The above operation is only valid with Focus 505 version with built-in wireless receiver (WR) module(s). Otherwise, the WR controls are redundant.

Installation of cable restraint

To prevent contact noise caused by constant tension applied to the connector, a cable restraint is designed such that tension is totally reduced when it is properly used. When the audio cable go through the cable restraint, it could prevent sweat from going directly into the electronic board via the connector. This is another advantage of the cable restraint.



Installation of Lavalier / Headset microphones or instrument inputs

Depending on customer requirements, Lavalier / Headset microphone or instrument inputs could be connected to the transmitter via the audio input connector. User is free to choose the various input sources but is advised to take note that connector used must be compatible to each other. The pin configurations of mini XLR connector are as follow figure.

■ mini XLR connector

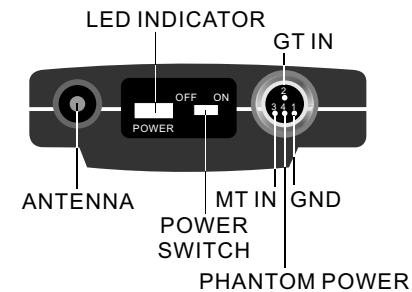

Beltpack Transmitter SM-916(UHF) / SM-316(VHF)

Battery installation

SM-916/SM-316 use a 9V battery. To insert the battery, first open the battery compartment cover by pressing the cover downward till the door flips open by itself (see below picture). When installing the battery, please beware of correct polarity. To put back the cover of the battery compartment, one has to press the cover in upward direction until it is locked.



Fig.1

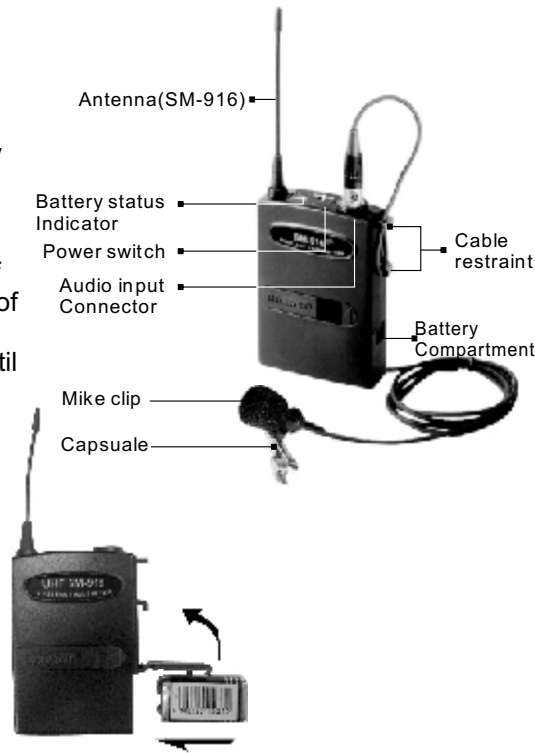

Channel selection and gain adjust

Channel selector and gain adjust are hidden in the designated cover of the front as illustrated. To make channel selection and gain adjust, please press the designated cover and flip it open as illustrated. Channel selection can be made by rotating the selector with a small screw driver.

Gain adjust for Lavalier and Headset microphones can be done by adjusting the MT switch, whereas GT switch is for the gain adjust of electric Guitar and other high- impedance line level inputs.

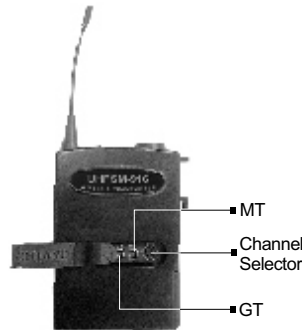

Operating the dynamic wired microphone.

To use a cable microphone, simply plug it into any MIC IN socket. The unique Neutrik combo socket accepts both phone and Cannon jack. Rotate the dedicated volume control knob and master volume control, amplified sound could be heard from the speaker when voice is spoken into the cable microphone.

Operation of system with CD / USB Player.

This operation is valid for version of Focus 505 with built-in " CD / USB Player ".

To operate, first turn on the Master power switch and then turn on the CD power cum volume control switch a little until LED next to it glow. The LCD panel on the player will be lighted up and normal operation is ready. To insert a CD, just push it into the CD slot and the mechanism will suck it in automatically.

Rotate the Power cum Volume control knob to adjust the volume of the player. For Bass and Treble setting, adjust the designated controls respectively. Clockwise direction to either control is to boost and counterclockwise is to back off its level. For more details, please refer to the explanation on " CD / USB Player " controls and functions.

Operation of system with Digital Recorder.

This operation is valid for version of Focus 505 with built-in " Digital Recorder " .

To operate, first turn on the Master power switch and then press the designated power button of this module. The LCD display will be lighted up and Volume setting can be done by rotating the knob. For Bass and Treble setting, adjust the designated controls respectively. Clockwise direction to either control is to boost and counterclockwise is to back off its level.

For more details, please refer to the explanation of " Digital Recorder " controls and functions.

How to remove / replace safely the cell / battery.

- * DO NOT expose the cell / battery to moisture or heat;
- * Avoid contact of the cell / battery with water or liquid;
- * DO NOT put the cell / battery in fire or expose to extreme temperatures and magnetic fields;
- * DO NOT reverse the polarity of the cell / battery or short circuit;
- * Always replace in sets the cell / battery and with the same type;

Operating the CD / USB Player

Front remotable is an unique feature of Focus 505. User can easily control this CD player by clicking its remote from both front and rear Focus 505.
To begin operation switch on the CD Power after the main power of Focus 505 has been turned on.

| Keys | Functions | Panel | Remote |
|-------------------|--|-------|--------|
| PLAY/ PAUSE | When this key is pushed during CD stop, play will start after track search. When this key is pushed during CD is playing, then it is changed to pause. When this key is pushed during CD is pausing, then it is changed to play. | ✓ | ✓ |
| STOP | When CD is not stop, if this key is pushed then CD will stop. | ✓ | ✓ |
| CD | When press this key will change to cd-mp3 mode. | ✓ | ✓ |
| USB | When press this key will changed to USB mode. | ✓ | ✓ |
| SKIP+ UP/CUE | In stop mode: Change the starting play track(file) during stop mode, cyclic to the first track if it is in the last track. In program entry mode: Change to the next track(file) for program select . In play mode, pause mode, program play mode, random play mode: Single pressed, skip the playing track(file) to next track(file) for normal play/pause mode, to next program index track(file) for program play/pause mode, to next random track(file) for random play /pause mode. Continue pressed , fast forward during play/pause when pressed more than 0.7sec. | ✓ | ✓ |
| SKIP- DONW/REV | In stop mode: Change the starting play track (file) during stop mode, cyclic to the last track, if it is in the first track. In program Entry mode: Change to the previous track (file) for program select. In play mode, pause mode, program play mode: Single pressed, skip the playing track (file) to precious track(file) for normal play/pause mode, to previous program index track(file) for program play/pause mode. Continue pressed, fast reverse during play/pause when pressed more than 0.7sec. | ✓ | ✓ |
| FOLDER-UP | In stop mode: Skip the starting play folder to next folder during stop mode, cyclic to the first folder if it is in the last folder. In program entry mode: Change the file for program select to next folder's first file, cyclic to the first folder if it is in the last folder. In normal play mode: Skip the playing file to the next folder's first file. | ✓ | ✓ |

Making changes to various settings in SM-5016

1.Making changes to CHANNEL / FREQUENCY:

Use UP or DOWN button to go to the CHANNEL /FREQUENCY page.



The cursor will flash to allow changes to be made. Pressing UP or DOWN button will increase or decrease the channel number. The corresponding frequency will change accordingly. When a desired channel(frequency) is being selected, it will be automatically saved and stored in the memory.

Remark : When changing transmitter frequencies, user should take care not to cause interference to other channels / users.

2.Making changes to Battery selection:

Use UP or DOWN button to go to the Battery selection page.



Press SET for about 2 seconds to activate the cursor. Press UP or DOWN button to move the cursor to either NiMH (rechargeable battery) or AKLN (Alkaline battery) position.

When the desired option has been selected, press SET for about 2 seconds to save and store the data in the memory.

Remark : "NiMH" must be selected when rechargeable battery is being used. Never select "AKLN" (Alkaline) when transmitter is intended for charging as Alkaline battery can not be charged ! Wrong selection of battery will cause battery sensing electronics to display wrong information and mislead charging status.

3.Input Level Gain Control Adjustment

Low impedance (Lo-Z) " MT" & high impedance (Hi-Z) " GT" gain controls are situated inside the transmitter. Gain controls are adjustment ports that enable you to use microphones of differing output levels and Guitar or instruments with Hi-Z output. To adjust microphone (Lo-Z) input levels, turn the "MT" control and to adjust the Guitar or instrument (Hi-Z) input, adjust the "GT" gain control to set the transmitter's desired audio input level.

UHF Beltpack Transmitter SM-5016

Parts & Functions



- 1 Antenna
- 2 Battery weak / audio mute indicator
- 3 Audio mute switch
- 4 Mini-XLR connector
- 5 Power ON / OFF switch
- 6 LCD display
- 7 Charging port
- 8 Cover release button
- 9 Charging contacts
- 10 Lavalier microphone
- 11 Mic clip

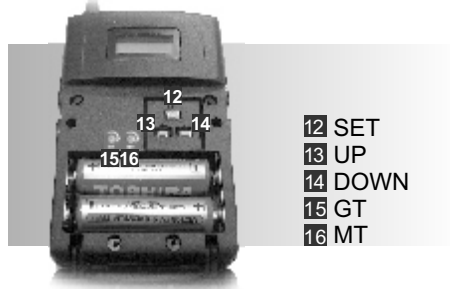

- 12 SET
- 13 UP
- 14 DOWN
- 15 GT
- 16 MT

Battery installation

SM-5016 uses 2 pieces of "AA" size batteries (Alkaline battery is recommended). To install or remove the batteries, press the release buttons at the edges of the transmitter to open or close the cover as illustrated below.



| | | | |
|-------------|--|--------|---|
| FOLDER-DOWN | In stop mode: Skip the starting play folder to previous folder during stop mode, cyclic to the last folder if it is in the first folder. In program entry mode: Change the file for program select to previous folder's first file, cyclic to the last folder if it is in the first folder. In normal play mode: Skip the playing file to the previous folder's first file. | ✓ | ✓ |
| PLAY MODE | In mp3 mode and in USB mode . If this key is pushed, PLAY mode is changed cyclically shown below. <pre> >PLAY ALL RANDOM → REPEAT TRACK → REPEAT FOLDER REPEAT ALL ← RANDOM REPEAT ← PLAY ALL ← </pre> IN CD mode If this key is pushed, PLAY mode is changed cyclically shown below <pre> > PLAY ALL RANDOM → REPEAT TRACK REPEAT ALL ← RANDOM REPEAT ← PLAY ALL ← </pre> | | ✓ |
| EJECT | When this key is pushed, door is moved out. | ✓ | ✓ |
| PROG | Set to programming mode. When programming mode, [stop] key is pushed then program is all cleared. | | ✓ |
| MUTE | When this key is pushed during CD is playing, the set will mute the output. Push again, will recovery the output . | option | ✓ |
| POWER | Power SW of the set . | ✓ | ✓ |
| ESP | In CDDA mode, Press"ESP" key , The ESP display lighted and the set is in electronic anti-shock state. The electronic anti-shock time is about 40 seconds. Press "ESP" key again, cancel the ESP function. | | ✓ |
| FIND | In MP3 mode : Press this key once FILE search mode changed . Press this key twice ALBUM search mode changed .If press this key long time once track is displayed .press twice ID3 TAG is displayed. | | ✓ |
| 0~10; | You can use these keys to select the track you want directly. | | ✓ |
| VOL.- | When this key is pushed , the volume will decrease by 1dB per step , the min. volume is 0dB. | ENCODE | ✓ |
| VOL.+ | When this key is pushed, the volume will increase by 1dB per step , the max. volume is 30dB. | ENCODE | ✓ |

Caution: This player does not accept 8-cm diameter CD.
User is advised to have the USB 2.0 formatted in " FAT " or " FAT 32 ".
The built-in USB 2.0 player can not be able to read the MP3 files stored in your USB if it is not formatted by either " FAT " or " FAT-32 ". To avoid damage to the USB, remember to detach it only after switching off the player.

Operating the Digital Recorder

Product Features :

1. Digital record to MP3 compression format
2. Highest sample rate at 44.1KHz, 128Kbps (as CD quality).
3. 1 - 99 recording tracks.
4. Equipped with 128MB flash memory for 60 min. recording time.
5. Available expanded memory socket of SD card. Up to 512MB
(When using 512 MB SD card, the recording time is available for over 8 hours.)
(If using 1G MB SD card, it will be divided into 99 recording tracks, each track with recording time less than 9:59:59 will be able to display time function on LCD.)
6. USB port to PC for easy download or duplication.
7. EQ mode selection (5 modes: Normal, Classic, Pop, Rock, Jazz)
8. REPEAT function (A-B Repeat, Repeat, Repeat All)..
9. Time counting
10. Two MIC-IN (L/L+R, R) jacks.
11. Line-in control key.
12. Stereo earphone jack.
13. Tack select, Play, Stop, Pause, Forward & Rewind control keys.
14. Mode control keys.
15. Rotary Volume Control for MIC REC. and Volume Level.

Usual manual of Digital Recorder & Player

1. Key---Power , REC , PLAY(II) , ■ , MODE , ▼ , ▲(/LINE IN) , A-B(/EQ) , ↻ (○) , <<(/VOC, /MP3) , >>(/DEL.)

2. Tracks----1~99 tracks. May store 99 tracks both in VOC mode and MP3 Mode, flash memory or SD card. Built-in 128MB NAND flash memory has a capacity of approx. 60 min. recording time.

3. LCD:



- 3-1 MODE key
- 3-2 EQ select(CLASSIC, POP, ROCK, JAZZ)
- 3-3 VOC mode
- 3-4 MP3 mode

VHF Handheld Transmitter Q-1002

Parts and Functions

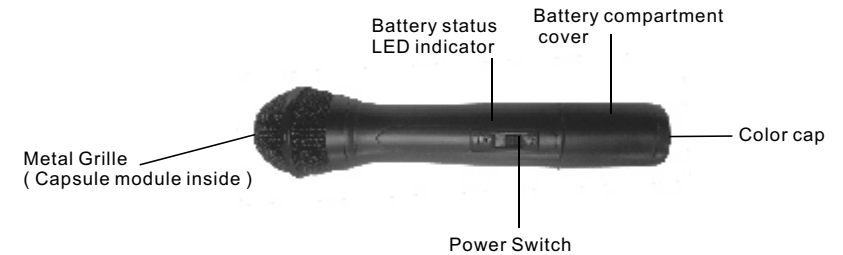

Battery Installation

Q-1002 uses 1 piece of 9V battery. To install new or replace the old battery, First unscrew the battery cap from the battery compartment, then insert the new battery according to its correct polarity as indicated. For longer operation hour, Alkaline battery is recommended!

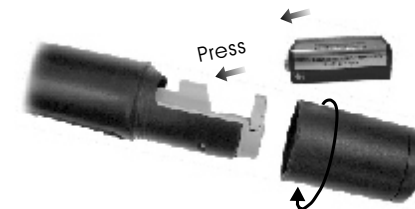

- After putting the battery cover back to the housing , slide the switch to "ON" position as shown below.



- As soon as the power is on, the battery-status indicator will give flash, indicating a normal operation. If there is no flash, it indicates either power supply is not available or battery is installed wrongly.
- After switching on, the Therefore signal indicator LED(s) of matching receiver will light up, indicating the microphone signal transmission is in normal operation.
- Switch off the power when the microphone is not in use, meanwhile, remove the battery out of microphone if it is not to be used for an extended period.

Handheld Transmitter SQ-816(UHF) / SQ-216(VHF)

Parts & functions

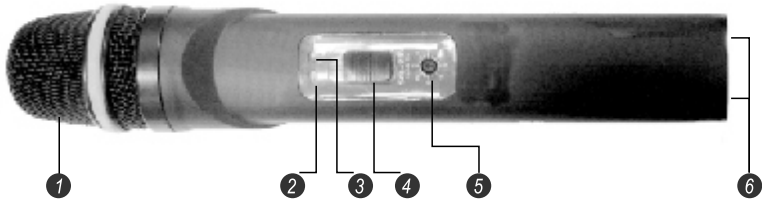

1. Capsule with metal grille
2. Battery normal indicator (Green)
3. Battery low indicator (Red)
4. Power on/off switch
5. Channel switch
6. Charging port

Battery installation

SQ-816/SQ-216 transmitter requires 3 pieces of "AA" size battery to operate. Please insert the batteries according to the correct polarity as indicated. To open the battery compartment, press and slide down the cover until it clicks and locks. Further sliding movement will remove the cover.



- 3-5 ● Recording
- 3-6 ▲ Playing
- 3-7 || Pause
- 3-8 DEL.: Delete file
- 3-9 A-B: A-B repeat
- 3-10 ↺ Repeat
- 3-11 ↻ Repeat All
- 3-12 LINE IN: Line-in audio source is available
- 3-13 ➡ Connecting to PC through USB
- 3-14 □□ Track no.
- 3-15 □□:□□ Time counting
- 3-16 F: Using flash memory
- 3-17 C: Using SD card

4.Key control

- 4-1 Power key**
- 4-2 Upper key** : Upper key for track selection. Track number will move quickly when push still for two seconds (this function will not work in MP3 mode).
- 4-3 Down key** : Down key for track selection. Track number will move quickly when push still for two seconds (this function will not work in MP3 mode).
- 4-4 REC key** : Record key. Select track no. in VOC mode in advance, push REC key to record, then push ■ key to stop record. If the track you want to record is occupied, the LCD will show "≡≡" you must delete the content of the track before you record. When the memory is with 30 seconds left, the LCD will start to count 30,29,28, 27.....6,5,4,3,2,1,0 You can use microphones LINE IN audio source or both mixed source for recording source.
- 4-5 Play/ || key** : Play key. Select the track no. you want to play, then push PLAY key to play. Push PLAY key during playing will pause play, then push PLAY key again to start playing. Push STOP Key to stop play.
- 4-6 ■ key** : STOP key. Push the key to stop all the motions, ex.: recording, playing, track selection..
- 4-7 ►►key(Forward)** : Forward key. The playing will move forward when press the key, back to normal speed when release the key.
- 4-8 ◀◀key(Rewind)** : Rewind Key. The playing will move rewind when press the key, back to normal speed when release the key.
- 4-9 A-B repeat key** : During playing, push this key to indicate any point as start point (A point) and finish point(B point) on a track, the machine will repeat from A to B point until you push the key again to release the function and continue to play.
- 4-10 ↺ & ↻ Repeat key** : In MP3 mode during playing, push REPEAT key once to "repeat the track" the LCD will show ↺, and push REPEAT key twice to "repeat all the track", the LCD will show ↻. Push the key at the third time to release repeat function. The "Repeat all" function can not be used in VOC mode.

5. **MODE** key----- Push the MODE key with another key for special function selection. The LCD will show "MODE" when push MODE key, you shall push another function key to perform the function. If you does not push another function key within 5 seconds, the machine will back to idle mode. Following is the detail of special function keys.
- 5-1 **MODE** key + **▲** (**/LINE IN**) key:LCD will show "LINE IN", and select line in audio source as recording source.
- 5-2 **MODE** key + **A-B** (**/EQ**) key :For EQ select function. EQ sequence is Normal 、 Classic 、 Pop 、 Rock 、 Jazz. (Normal EQ will not be shown on LCD)
- 5-3 **MODE** key + **◀◀** (**/VOC,/MP3**) key: To select VOC mode (Record from microphone or LINE IN source) or MP3 mode (Download *.mp3 files from PC).
- 5-4 **MODE** key + **▶▶** (**/Del.**) key : When push these two keys, the LCD will show DEL,you must push **▶▶** (**/Del.**) key again to delete the track. The LCD will show"DEL" until the delete process is finished.
- 5-5 **MODE** key + **■** **key** :Change flash and SD card under PLAY and Idle modes.

6. The machine offers extended connectors:

- 6-1 **EAR** :for earphone
 6-2  :USB connector to PC
 6-3 **SD card**:for extended SD memory card,up to 512MB
 (When use 512 MB SD card, the recording time is available for over 8 hours)
 (If use 1GMB SD card, it will be divided into 99 tracks recording, each track of recording time no more than 9:59:59 will be able to display time function on LCD)
 6-4 **MIC IN** : connect to two microphones

7. ROTARY VOLUME CONTROL

- 7.1 **MIC REC.** Rotary Volume Control
 7.2 **Level** Rotary Volume Control.

8. **USB CONNECTION** : You can easily copy MP3 files from computer to the machine through USB connection.

A. Install Hardware: Connect the machine and your computer with a USB cable. You computer will recognize a new removable storage device automatically. You can add, delete, copy, and preview files. (If the operation system of your computer is Window 98 or below, you must install USB driver for first use. The USB driver is included.)

B. Store new files to VOC mode: MP3 files on the computer can be stored to VOC mode. However, the file names must be renamed as following format:

- B-1** : If you want to store the file to flash memory in VOC mode, you must rename it asM_INT_XX.MP3 (XX stands for track location)
B-2 : If you want to store the file to SD card in VOC mode, you must rename it as M_EXT_XX.MP3 (XX stands for track location) **File format must be MP3 to work.**

C. Store new files to MP3 mode: *.mp3 or *.wma files on the computer can be stored to MP3 mode, no need to rename the file, it will store to MP3 mode automatically.

E: After completing all operations on computer, please detect the USB connection then to operate the machine.

***** NOTICE : Please read the following notice before you use our DIGI- REC Series .**

Handheld Transmitter SQ-916(UHF) / SQ-316(VHF)

Parts & functions

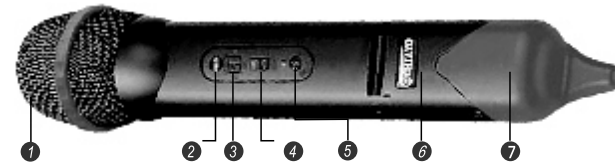

1. Capsule with metal grille
2. Battery indicator
3. Sensitivity switch
4. Power on/off switch
5. Battery cover
6. Battery cover
7. Color cap

Battery installation

SQ-916/SQ-316 use a 9V battery for power. To change or replace the battery, please remove the color cap first, then press the bottom of battery compartment to release the cover as shown below.

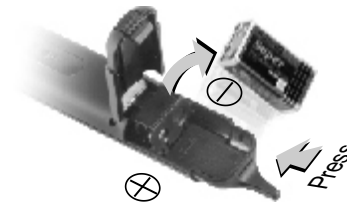

Sensitivity switch

This microphone has a sensitivity switch. For close mouth singing or normal speech, please put the switch to L (Low) position. For tripod-mount speech, please put the switch to N (Normal) position.



■ Low Sensitivity

■ Normal Sensitivity

Making changes to various settings in SQ-5016

1. Making changes to Channel:

Use UP or DOWN button to go to the CHANNEL/ FREQUENCY page. The cursor will flash to allow changes to be made. Pressing UP or DOWN button will increase or decrease the channel number. The corresponding frequency will change accordingly. When a desired channel is selected, it will be automatically saved and stored in the memory.



2. Making changes to Battery selection:

Use UP or DOWN button to go to the Battery selection page.



Press UP or DOWN button to move the cursor to either NiMH (rechargeable battery) or AKLN (Alkaline battery) position.

When the desired battery has been selected, it will be automatically saved and stored in the memory.

Remark : "NiMH" must be selected when rechargeable battery is being used. Never select "AKLN" (Alkaline) when transmitter is intended for charging as Alkaline battery can not be charged ! Wrong selection of battery will cause battery sensing electronics to display wrong information and mislead charging status.

3. Making changes to Sensitivity Level:

Use UP or DOWN button to go to the SENS SET page.



Press UP or DOWN button to increase or decrease the Sensitivity Level of the transmitter. The MAX level is 4 and the MIN level is 1.

When a desired sensitivity level has been selected for your application, it will be automatically saved and stored in the Memory.

Remark : When selecting Sensitivity level, please keep in mind that Level 1 is for close proximity singing purposes whereas Level 4 is for use of transmitter on tripod mount for speech purposes. When Level 4 setting is used for close proximity singing, high SPL input will result in undesirable distortion in the output.

After performing setting changes, you could turn the protective cover 180° in either direction to block the buttons from being accidentally adjusted.

9. Please use the one with cooperate specification (marks on the back of the machine). Please turn off the power when you do not use the machine for a period of times.
 - * To keep stable data transmission, please do not twist the USB cable during data transmission.
 - * Please do not press the LCD monitor heavily, or touch it with finger or sharp articles.
 - * Please prevent water leak into the machine.
 10. The SD card is a very precise electronic part, please use it according to the following notice:
 - *To prevent taking the SD card out of the machine during data transmission.
 - *Do not bend, strike, drop or take apart the SD card.
 - *To prevent to place the SD card in a high temperature, high humidity, dusty place, or a place full with static electricity.
 - *Please make sure the SD card you are using has been format.
 - *Make sure the write protection switch of the SD card is released when you are recording .
 - *Our product will process large amount of messages during recording and playing, we strongly suggest you to use high speed SD card as extension memory card, to prevent noise, data lose or any transmission problem.
- * We have tested and approval the following brands of SD card for our machine, they are:**
- Toshiba SD-M51225R2W 512MB
 - Apacer SD 120X 1GB
 - Apacer SD 256MB
11. We do not guarantee the function, operation, or life of any SD card is used in our machine. We do not also take any responsibility of indemnity for the damage of SD cards.
 12. Same as other digital stock products, user must save the inner documents from time to time. This product will not take any responsibility due to documents lost directly or indirectly damage caused.

FCC Caution:

To assure continued compliance, any changes or modifications not expressly approved by the party responsible for compliance could avoid the user's authority to operate this equipment. (Example - use only shielded interface cables when connecting to computer or peripheral devices.

This device complies with Part 15 of the FCC Rules and RSS-123 of Canada.

Operation is subject to the following two conditions:

- (1) This device may not cause harmful interference, and
- (2) this device must accept any interference received, including interference that may cause undesired operation.

Battery replacement / installation of Focus 505

Step 1: Press and release the cover from the battery compartment.



Step 2: Pull out the battery and disconnect the battery cables.



Step 3: Connect the cables to the new battery and slide it into the compartment in the same direction the previous one was pulled out and the “+”, “-” corners facing right & up.



Step 4: Put the cover back and the replacement / installation is completed.



Note: Please make sure the battery is installed in the correct direction to avoid possible damages to itself and the amplifier.

UHF Handheld Transmitter SQ-5016

Parts and functions

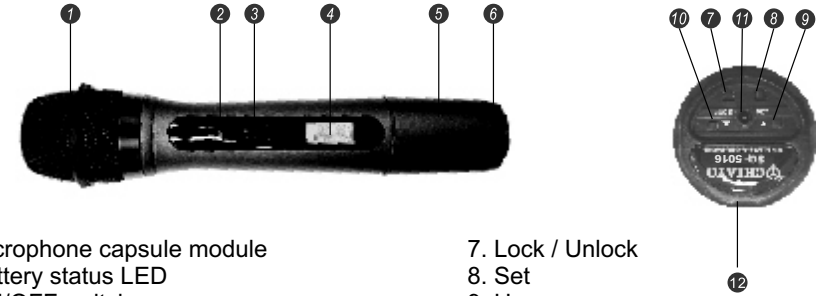

- | | |
|--|-------------------|
| 1. Microphone capsule module | 7. Lock / Unlock |
| 2. Battery status LED | 8. Set |
| 3. ON/OFF switch | 9. Up |
| 4. LCD | 10. Down |
| 5. Battery compartment | 11. Charging port |
| 6. Rotating protective cap for controls (also serves as color identification cap) | 12. Name plate |

Changing of capsule

First unscrew the metal grill from the housing and take out the capsule to be replaced. Then insert a new capsule. Either dynamic or condenser type can be chosen from location to location.



Battery installation

SQ-5016 microphone requires 2 pieces of "AA" size batteries to operate. Please insert the batteries according to the correct polarity as indicated.

Caution

Many batteries are known to have leakage problem of conductive and corrosive liquid. Please observe the rule to remove the batteries if they are not to be used for a longer period. Due to various unstandardized sizes (diameters) of "AA" batteries, this battery compartment is designed to accommodate the most common Alkaline batteries only.