

Class D loop amplifier



LD SERIES

1-CHANNEL LOOP AMPLIFIER

EN

Installation and user
manual
LD 1.0 / 2.0 / 3.0



OPUS
Technologies

TABLE OF CONTENTS | EN

1. Introduction	5
1.1 Purpose	5
1.2 Target audience	5
1.3 Alerts	5
1.4 Icons	5
2. Loop amplifier presentation	6
2.1 Description	6
2.2 The range	6
2.3 Package contents	6
2.4 Rack mounting kit: OP-R (optional)	6
2.5 Advice and safety	7
3. Technology presentation	8
3.1 What is an AFILS (Audio Frequency Induction Loop System) ?	8
3.2 Working principle	8
4. Controls, connections and adjustments	9
4.1 Control	9
4.2 Multi-loop output	9
4.3 Front panel and adjustments	10
4.4 Rear panel and adjustments	11
4.5 Rack mounting	12
4.6 Adjustment and connection	14
4.7 Connecting two amplifiers	16
5. Setup	18
5.1 Setting up a simple perimeter loop	18
5.2 Setting up a Master and a Slave amplifiers	18
5.3 Securing settings	19
5.4 Metal loss compensation adjustment	19
5.5 Operation of the fault contact	19
5.6 Audio input	19
6. Functioning and planning of a loop system	20
6.1 Preamble	20
6.2 Working principle	20
6.3 The different types of installation.	21

TABLE OF CONTENTS | EN

7. The magnetic induction loop	23
7.1 Installing your loop	23
7.2 Cable section	23
7.3 Connection	23
7.4 The magnetic field	23
7.5 Technical study	24
8. Installation constraints	27
8.1 Magnetic overspill	27
8.2 Metal distortion	27
9. Information	28
9.1 Maintenance and care	28
9.2 Warranty	28
9.3 After-sales service and return	28
9.4 Disposal of used electric and electronic units	28
9.5 Technical specifications	29
9.6 CE certification	30
Certificate of conformity to the IEC-60118-4 standard	31

1. Introduction

Thank you for having purchased an Opus Technologies LD SERIES class D loop amplifier. Please take a few moments to read this manual, it will ensure the optimal use of the product and many years of flawless service.

1.1 Purpose

The installation and user manual provides the needed informations to install, configure and to use your LD Series amplifier.

1.2 Target audience

The installation and user manual is destined to Opus Technologies' LD Series amplifiers installers and users.

1.3 Alerts

This manual mentions three types of warning. The type of alert is closely related to the effect that may occur if the alert is not observed. These alerts, ranked in increasing order of severity, are as follows:

- **Caution**

Failure to follow a cautionary warning may result in property damage.

- **Warning**

Failure to heed a warning may result in serious property damage and potential personal injury.

1.4 Icons

1.4.1 Note Icons

Warning icons used with the notes provide additional information about the note. See the following examples:

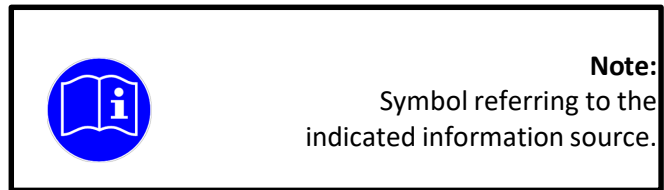

1.4.2 Caution, warning and danger icons

The icons used in combination with Caution, Warning and Danger indicate the type of risk. See the following examples:

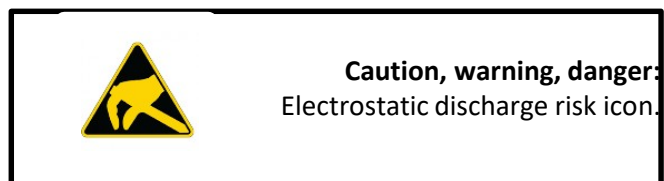
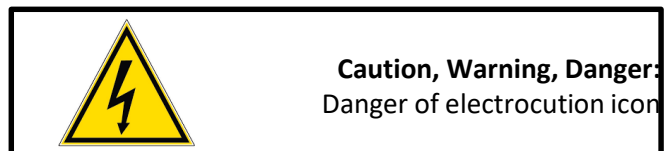
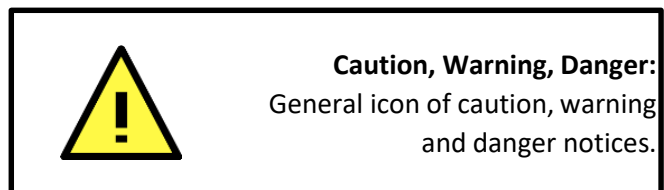

2. Loop amplifier presentation

2.1 Description

The LD range is composed of magnetic induction loop amplifiers allowing to equip rooms for people suffering from hearing loss.

The LD Series has been developed with strict and rigorous specifications that allow us to offer a 5 year warranty. The products have been designed with options to facilitate their use and installation.



Product picture Figure 1

The range of single channel amplifiers is composed of the LD1.2, LD2.2 and LD3.2. They allow to cover different surfaces as described below.

2.2 The product range

Opus Technologies' LD1.0, LD2.0 and LD3.0 are a new generation of magnetic loop amplifiers, made in France. These robust amplifiers are the most compact on the market while offering the necessary features (AGC, MLC, compressor, fault monitoring, etc.) to ensure an installation in rooms from 100m² to 1000m².

- LD1.0 covers up to 250 m² - max width : 10m
- LD2.0 covers up to 450 m² - max width : 15m
- LD3.0 covers up to 1000 m² - max width : 20m

These coverage informations are given on an indicative basis and depend on the configuration of the room and project constraints (presence of metal structures, overspill, room width, etc). Not taking these constraints may lead to an installation not complying with the IEC-60118-4 standard requirements. It is essential to consult a loop specialist for your project design. Our Smartloop simulation software will help you designing project complying with the IEC-60118-4 norm. Contact your closest distributor for more information.

2.3 Package contents

Upon reception of your amplifier, inspect the unit to check if any damage have occurred during shipment. If damages are noticed, report immediately to your distributor and shipping company, indicating the date of delivery, the nature of the damage, if it was visible on the packaging before unpacking. If possible, give the delivery note number and a tracking number.

Package contents:

- LD1.0, LD2.0 or LD3.0 amplifier
- Power cable 1.5m, CEE 7/7 - C13 connectors
- 2x 3-pin connectors
- 1x 2-pin connector, output
- 1x 2-pin connector, input
- A set of 3 stickers "Area adapted for the hard of hearing people".
- Installation and user guide
- OP-R rack mounting kit (optional)
- Warranty certificate

If any pieces are missing, please contact your reseller or the manufacturer directly.

2.4 Rack mounting kit: OP-R (optional)

OP-R contents

- 2x rack mounting brackets
- 2x mounting brackets
- 8x mounting screws



Amplifier picture -Figure 1

2.5 Advice and safety

Most of defective loop installations are the result of a lack of preparation. Take your time before starting your installation

Ideally, the loop driver should be placed near the area to be covered. This may involve placing the loop driver on a panel/wall, under a desk or under a counter. Wall mounting accessories are provided in the OP-R mounting kit.



Refer to figure 9 on page 13

To choose the location for your loop, take into consideration the area that would be most likely used by the end user. This area is called the “listening area”.

For example, in a concert hall, you'll install your loop cable around the audience area rather than the whole room. Covering also the stage may lead to feedback effect due to a conflict between the loop magnetic field and the dynamic microphones (guitar, bass..) of the band playing on the stage

- To prevent accidents or personal injury caused by electrical shocks, never place any type of container filled with a liquid, such as a vase, on or around the device.
- Never pull on the power cord to remove the plug from the wall outlet; always pull the plug.
- Do not operate the device near heat sources or in rooms with high humidity. (Operating temperature range 0-45°C).
- Do not cover the air vents so that any heat generated by the device can be dissipated by air circulation.
- Depending on the stress it is exposed to, the device can develop high temperatures in the heat sink and at the air vents. Be careful not to touch these elements - risk of burns!
- An installation must be carried out by qualified personnel.
- The device must be out of reach of unauthorized persons.

- The device may only be operated by trained staff qualified for loop installation.
- The device is intended to be used for inductive loop systems only.
- To prevent potential injury, do not position this device higher than 2 meters from the ground
- Connect the loop driver only to wiring which complies to IEC-60364.

3. Technology presentation

3.1 What is an AFILS (Audio Frequency Induction Loop System)?

An induction loop system is intended to help hard of hearing people to receive a clear audio signal into their hearing aid without being disturb by background noises . Thanks to this system, the sound coming from an audio source (speaker microphone, sound system, television) is transmitted by induction to hearing aid user who can thus enjoy clear sound without being disturbed by any ambient noise. This system is mainly used in public places (conference rooms, cinemas, courts, churches, ticket offices, etc.) but can also be installed at home. Many conventional hearing aids have a "T" loop function.

3.2 Working principle

A magnetic loop system consists of an electric wire Layed down around a room forming a loop. The cable is connected to a loop amplifier, connected itself to an audio source. The loop amplifier convert the audio signal into electric pulses transmitted through the cable, creating a magnetic field. Hearing aids equipped with a coil (often called a "T" or "T-coil".) will capture this signal and transmit it to hearing impaired.

By induction, the electrical signal present in the loop will be reflected in the coil of the hearing aid. The coil transmits the signal of the loop in the internal amplifier of the prosthesis, which then bring it to the ear of the hearing impaired person, free of background noise and environmental disturbances.

The audio source can come from various origins. In a cinema, for example, the sound of the film will be transmitted. In a conference room, the sound of the speaker's microphone will be transmitted. In a subway station, the voice of the agent will be transmitted...

The loop can be installed on the floor or ceiling. The loop is integrated into the building, just like the electrical installation.

The presence of a hearing loop is often indicated by a blue logo representing a barred ear and the letter "T".



Refer to figure 2



Pictogram used to indicate a loop system - Figure 2

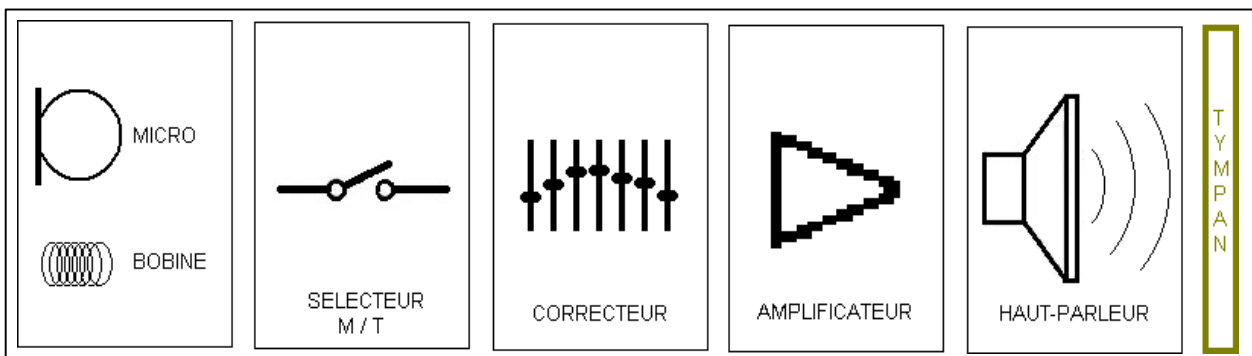

Hearing aid operating diagram with the T-position - Figure 3

4. Controls, connections and adjustments

4.1 Control

The amplifiers comes with a fault synthesis allowing you to monitor the main functions of the unit, such as the amplifier's power, the integrity of the loop cable connected to the amplifier and the inputs.

If any of the functions are faulty and not working properly, a red LED on the front panel of the amplifier lights up and the fault relay opens (NO: Normally Open).

4.2 Multi-loop output

The LD1.0, LD2.0 and LD3.0 amplifiers have two OUT 0° and 90° outputs and one IN input on the rear panel (see Figure 5 on page 11). This feature offers the possibility of combining several amplifiers together.

Depending on the layout of the loops, the aim is to control the external overspill of the magnetic field and/or the homogeneity of coverage or the coverage area.



Refer to section Layout page – 24

For more information on the installation of a loop using a master loop and a 90° phased shifted slave loop, contact your local distributor, contact your local distributor.

You can also use our Opus Smartloop simulation software or contact us at contact@opus-technologies.fr.

4.3 Front panel and adjustments

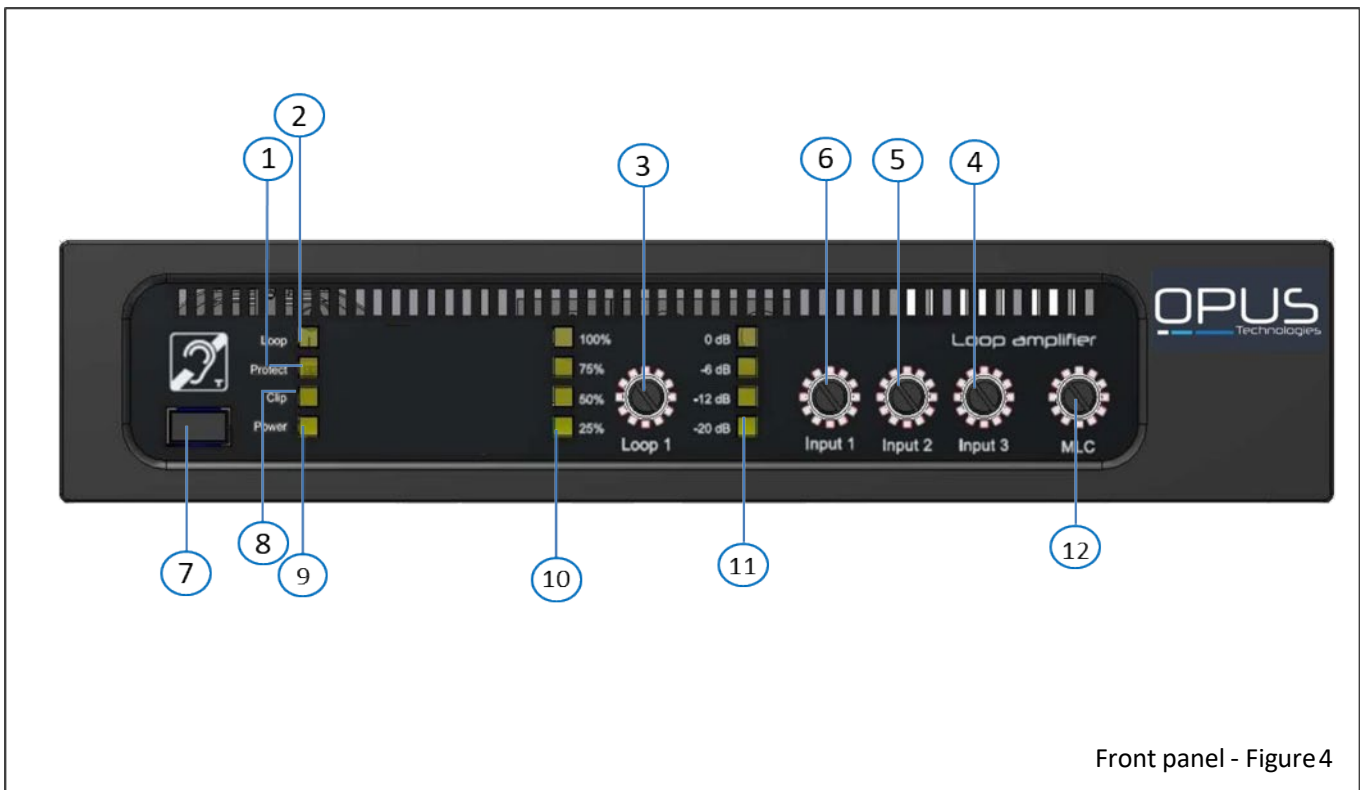

Front panel - Figure 4

1. **"Protect" LED, fault summary display.** Error indicator. This red LED lights up when the master loop amplifier is overloaded, when the input level of the master loop is too high or when the master loop is defective.
2. **"Loop" LED, loop presence.** This green LED is displayed when the loop is in working condition.
3. **Output current adjustment.** Allows you to control the electrical output current distributed in the loop.
4. **INPUT 3 (100V) input adjustment.** This controls the signal of the INPUT 3.
5. **INPUT 2 (line or microphone) input adjustment.** Allows to control the signal of the INPUT 2.
6. **INPUT 1 (line or microphone) input adjustment.** Allows to control the signal of the INPUT 1.
7. **ON/OFF power push button.**
8. **"Clip" LED, amplifier saturation display.** Error indicator. This red LED lights up when the Slave loop amplifier is overloaded, when the input level of the Slave loop is too high or when the Slave loop is faulty.
9. **"Power" LED, ON/OFF display.** Power on indicator light.
10. **Input signal meter.** Indicates the input signal level after adjustment.
11. **Output signal meter.** Indicates the electrical current in the induction loop.
12. **MLC (Metal Loss Compensation) setting** reduces interference problems due to the presence of metal structures.

4.4 Rear panel and adjustments

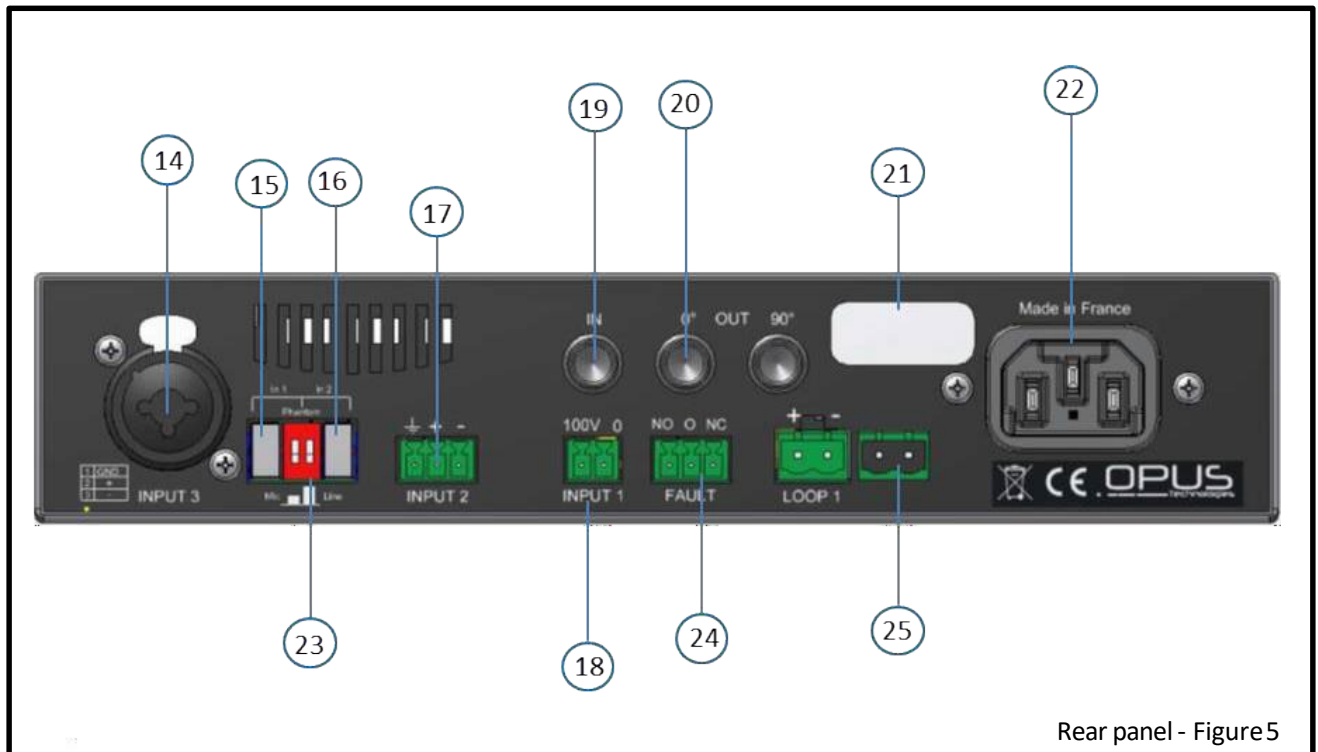

Rear panel - Figure5

13. **INPUT 3 Combo audio input: microphone or line.** This input allows you to connect external audio inputs from a line level source (mixer, pre-amp, etc.) or from a microphone. The Combo connector accepts an XLR or a 6.35 jack.
14. **Push button for line or microphone communication of the INPUT 1 input.** Switch to commute the input according to the source (microphone or line).
15. **Push button for line or microphone communication of the INPUT 2 input.** Switch allowing to commute the input according to the source (microphone or line).
16. **INPUT 2 Phoenix type terminal block: microphone or line.** This terminal block input is used to connect external audio inputs from a line level source (mixer, preamp, etc.) or from a microphone.
17. **INPUT 1 Phoenix type terminal block: 100V priority.** This terminal block input allows you to connect an external audio input from a 100V sound system, the audio is directly recovered from the speaker's line.
18. **Slave IN input.** This input is used to connect a 0° or 90° output (Master/Slave) from another LD series loop amplifier.
19. **0° or 90° OUT output to slave amplifier.** These outputs are used to connect the Master amplifier to a Slave loop amplifier from the LD range.
20. **Location of the serial number label.**
21. **Mains power cord connection.** Connects the loop amplifier to the power supply.
22. **Phantom power selection switch.** Allows you to send or not voltage to supply a microphone connected to INPUT 1 and/or INPUT 2.
23. **NO/NC fault relay.** Allows the system status information to be sent via a relay.
24. **Loop output on Phoenix type terminal block.** Allows to connect the loop wire to the amplifier.

4.5 Rack mounting

4.5.1 Ventilation and rack mounting

For better ventilation we recommend leaving a space of 1U (44 mm) above the amplifier.

Leave at least 168 mm (5.5") of space between the bottom of the rack and the amplifier.

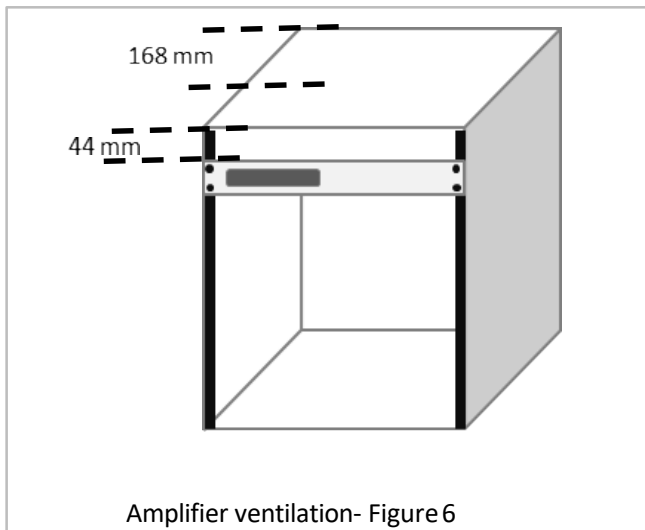

4.5.2 Rack integration

Required accessory: OP-R* mounting kit

Attach the rack mounting brackets as shown below (Figure 7) using the mounting screws provided in the kit.

Then integrate the amplifier into the rack.

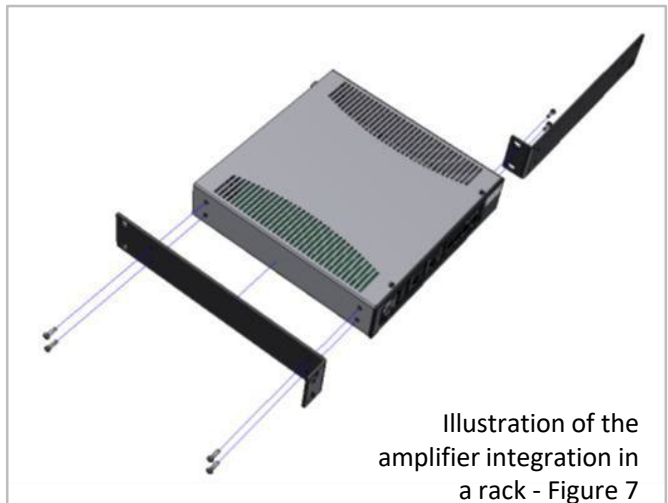

Caution, warning, danger:

The LD1.0, LD2.0, LD3.0 amplifiers contain an advanced protection circuit, which allows them to reduce the output power to maintain safe operating temperatures. Insufficient ventilation may cause a reduction of the amplifier's output power during normal operation (indicated by illumination of the red CLIP/PROTECT LEDs). To reduce the risk of thermal limitation and allow proper heat dissipation, it is recommended to keep clear the space directly above and behind these amplifiers. It is also highly recommended not to place anything directly on top of the amplifier.

**The OP-R mounting kit is not supplied with the one-channel amplifiers (LD1.0, LD2.0 and LD3.0) of the LD series.*

4.5.3 Rack-mounting two loop amplifiers

Required accessory: OP-R* mounting kit

Attach the rack mounting brackets as shown below (Figure 8) using the mounting screws provided in the kit. Then attach the amplifiers to each other with the mounting brackets.

Finally, integrate the amplifier into the rack.

Note: The OP-R mounting kit is not supplied with the one-channel amplifiers (LD1.0, LD2.0 and LD3.0) of the LD series.

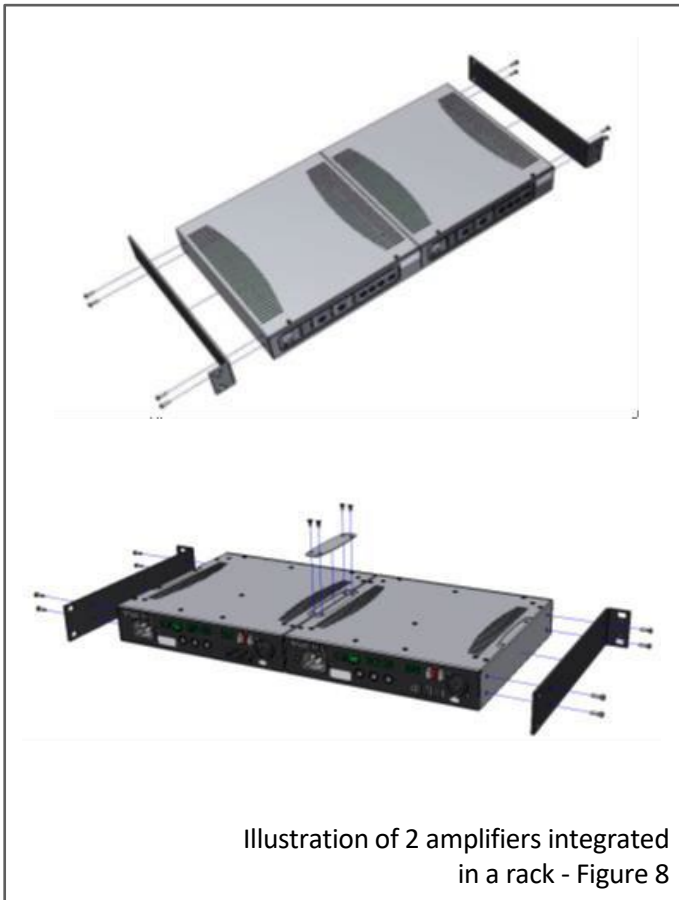

4.5.4 Mounting the loop amplifier on a wall

Required accessory: OP-R* mounting kit

Attach the mounting brackets as shown below (Figure 9) using the screws provided in the kit.

Then, attach the amplifier to the selected wall.

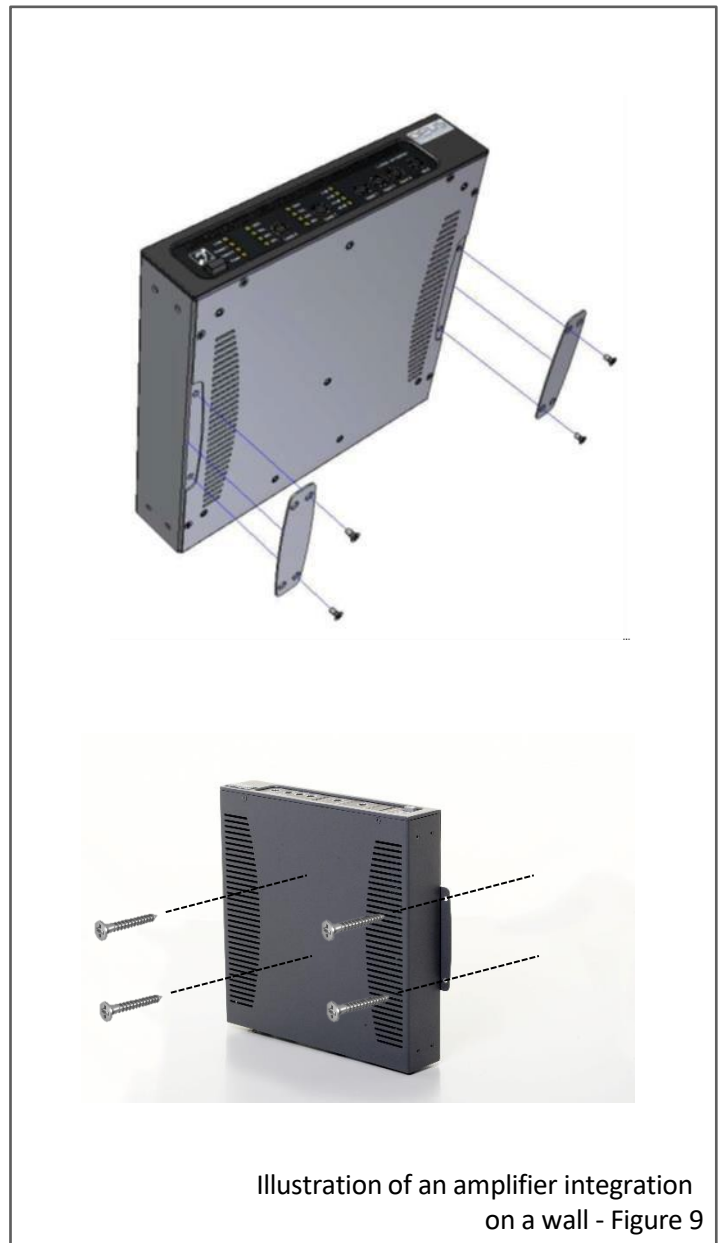

**The OP-R mounting kit is not supplied with the one-channel amplifiers (LD1.0, LD2.0 and LD3.0) of the LD series.*

4.6 Adjustment and connection

4.6.1 Loop connection

The loop is connected via a green 2-point terminal block located on the rear panel of the amplifier, thanks to a twisted cable.



Distance between the loop and the amplifier must not exceed 15 m.

The twisted cable cancels the magnetic field and avoids inductions potentially created by transformers external to the system. The references OP-LI5/10 or 15 allow to create this type of connection.

The loop circuit must use cabling conforming to the IEC-60332-1-2, 60332-1-3, 60332-2-1, 60332-2-2 or 60695-11-21 standards.

4.6.2 Audio inputs

The audio sources are connected via the 3 inputs of the amplifier provided for this purpose. The LD Series have 3 inputs:

- Input 1: 100 V
- Input 2: lines or microphones
- Input 3: lines or microphones

4.6.3 Priority INPUT 1 100V input

The INPUT 1 (100V) of the LD series amplifiers has a priority for security sound systems in case of evacuation of the building.

If more than one audio source reaches the amplifier's inputs, the priority input will always have priority over the others, and the INPUT 2 and/or INPUT 3 will be muted. In some cases, and if the configuration allows it, we recommend connecting the room sound system to INPUT 2 and INPUT 3 and the security sound system to INPUT 1.

4.6.4 Input and outputs jack 6.35

On the rear panel of the amplifier you can see three 6.35 jack inputs. These inputs and outputs allow you to connect several loop amplifiers together to create single phased loop systems, low loss systems or ultra low loss systems.

Refer to the types of connection in paragraph 4.7 and the different types of installation in paragraph 6.

4.6.5 Line output

It is possible to connect a recorder to the line output of the loop amplifier. The line output of the amplifier is a 6.35 OUT 0° jack which is mainly used to link several amplifiers when setting up complex systems (low spill system) but the output can also be used as a single line output.

4.6.6 Power supply

The LD amplifiers have an integrated power supply of 230V (or 115V), with a power of 300VA.

4.6.7 Status relay

The status output is used to send a status of the loop amplifier to external devices via a NO/NC relay.

4.6.8 Connectors

Symmetric:

- Pin 1 : Mass/Ground/ Schield
- Pin 2 : Hot spot (+)
- Pin 3 : Cold spot(-)

Asymmetric:

- Pin 1 : Mass/Ground
- Pin 2 : Signal (+)
- Pin 3 : Connected to mass (pin 1)

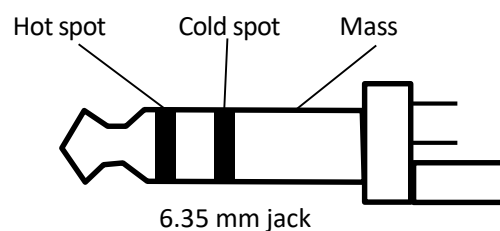
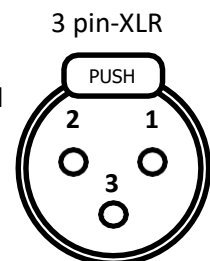

4.6 Adjustment and connection

4.6.9 Switching on



The unit is powered up using the grey switch on the front of the amplifier. If the amplifier is powered up the Power LED will light up in blue.

To turn the unit off, press again the Power switch on the front of the amplifier again. Please note that the unit goes into standby mode when it is turned off. Unplug the power plug from the wall outlet to completely turn off the unit.

4.6.10 Loop integrity

The green LED on the front of the amplifier is used to check the loop integrity. If the loop is cut or if the loop impedance is not between 0.5 and 3 Ohm the Loop LED will not be displayed and the Protect LED will be light up. (See figure below)

4.6.11 Protect and Clip LEDs

The " Protect " and " Clip " LEDs light up if :

- The ohmic resistance of the inductive loop is not between 0.5 and 3 Ohm.
- The corresponding conductor section is overloaded or overheated.
- The input level is too high, causing clipping of the audio signal.

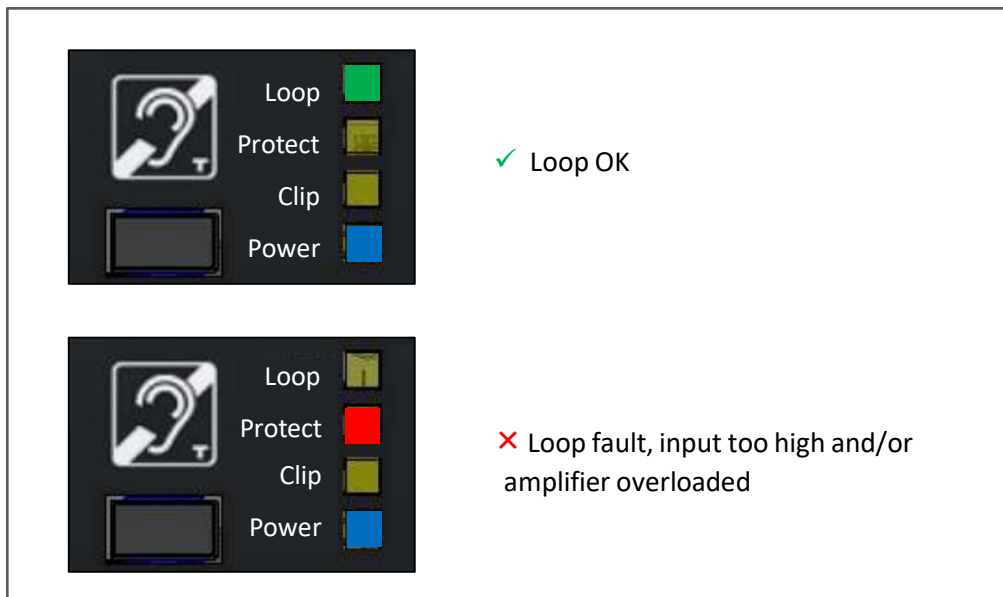

4.7 Connecting two amplifiers

4.7.1 Master over 1 Slave



To expand and duplicate an installation or to use a low spill system or high coverage system with the LD Series 1-channel amplifiers:

1. Connect the loops to the terminals provided: amplifier Loop terminal.
2. Insert an audio source into INPUT 1, 2 or 3 of the master amplifier.
3. Connect the OUT 90° output of the Master amplifier to the Slave amplifier using a 6.35mm link cable.
4. Turn on the amplifiers and adjust them accordingly.

4.7.2 Slave to slave

Connect the OUT jack (0° or 90°) of the slave loop amplifier to the IN jack of the next slave loop amplifier.

This allows you to connect several slave amplifiers. (See diagram on next page)

This allows you to use multiple amplifiers on the same input. This can be useful for very large rooms or if several rooms share the same audio transmission.

4.7.2 Master to several slaves

Master amplifier

Slave 1 amplifier



Slave 2 amplifier

Slave 3 amplifier



Slave 4 amplifier



To use a low spill or very high coverage system:

1. Connect the OUT 90° jack of the master loop amplifier to the IN jack of the next slave loop amplifier (Slave Amplifier 1).
2. Connect the OUT 0° socket of amplifier 1 to the IN socket of the next amplifier (unit 2).
3. Connect the OUT 90° socket of amplifier 2 to the IN socket of the next amplifier (unit 3).
4. Connect the OUT 0° socket of amplifier 3 to the IN socket of the next amplifier (unit 4).
5. Repeat if necessary.
6. Connect the respective out-of-phase loops to the terminal blocks of the corresponding amplifiers.
7. Switch on the amplifiers and adjust them accordingly.

This type of configuration will be used to cover large areas such as those of exhibition parks or sports halls or to equip several areas with the same audio source.

5. Setup

5.1 Setting up a simple perimeter loop

1. Turn on your amplifier and check that all the potentiometers are at 0 level
2. Connect your loop to the Loop 1 terminal block
3. Connect a 1kHz sinusoidal source to one of the inputs
4. Increase the input signal via the potentiometer on the front of the amplifier until you reach between -6 and 0 dB.
5. Increase the output current via the Loop 1 potentiometer on the front panel of the amplifier until you reach between 75% and 85%.
6. Take a magnetic field meter such as OP-FSM* and make a first measurement at the center of your room.
7. Then readjust the settings until you reach -3dB at the center of the zone
8. Then follow the test procedure described in the OP-FSM manual for an installation that meets the IEC-60118-4 standard.

5.2 Setting up a Master and a Slave amplifiers

5.2.1 Master loop amplifier

To know the different types of implementation of a low spill loop system or single phased loops, refer to paragraphs 6.3.2 and 6.3.3.

Depending on the type of LD series amplifier, the settings will be different:

- LD1.0/2.0/3.0 series units (not covered in this user manual) incorporate one amplifier per unit so you'll need two devices to process a phase shift Installation
- LD1.2/2.2/3.2 series incorporate two amplifier in one unit allowing you to use only one device for low spill systems. A second device will be required whenever a 3rd loop is installed.

The Master amplifier is the unit to which the audio signal at input 1, 2 or 3 is connected. This will be the basic signal. The phase shift module integrated in the units will then shift this signal by 90° or 0° to inject it into the next slave amplifier.

There is no special adjustment to determine the Slave amplifier, only the connection arrangement will define the Slave and Master amplifiers.

1. Power up your amplifier and check that all the potentiometers are at 0
2. Connect your loop to the Loop1 terminal block
3. Connect a 1kHz sinusoidal source to one of the inputs
4. Increase the input signal via the potentiometer on the front of the amplifier until you reach between -6 and 0 dB of the input meter
5. Increase the output current via the Loop 1 button on the front panel of the amplifier until you reach between 75% and 85%.
6. Take a magnetic field mesurer such as OP-FSM and make a first measurement at the center of your room
7. Then adjust the settings according to the measurements made with your magnetic field mesurer in order to achieve homogeneous coverage in accordance with the IEC60118-4 standard.

5.2.2 Slave loop amplifier

8. Turn on your amplifier and check that all the potentiometers are at 0 level
9. Connect your loop to the Loop 1 terminal block
10. Connect the master amplifier via a 6.35mm jack cable to the 6.35mm IN jack
11. Increase the output current via the Loop 1 button on the front panel of the amplifier until you reach between 75% and 85%.
12. Take a magnetic field meter such as OP-FSM and make a first measurement at the center of your room

5.2.3 Final adjustments

13. Connect the two loops and then adjust the settings until a minimum signal of -3dB is achieved in the weakest audio reception area.
14. Then follow the test procedure described in the OP-FSM manual to perform an installation according to the IEC-60118-4 standard.

Note: You can download a sample certificate of conformity from our website www.opus-technologies.fr in the download section. Or use the one provided at the end of this manual.

For more information on IEC-60118-4 standard adjustments contact us at contact@opus-technologies.fr or contact your local reseller.

5.3 Securing the settings

The OP-V plexiglass plate (option: not supplied) allows you to lock the settings while viewing the amplifier's information LEDs.

This plexiglass can be installed with or without the OP-R rack system.



5.4 Metal loss compensation adjustment



If you detect signal distortion due to presence of metal structure turn the MLC (Metal Loss Compensation) control on the front panel of the amplifier clockwise.

Check your high frequency measurements with a 4kHz sinusoidal signal and adjust the compensation settings to achieve acceptable measurements to the IEC-60118-4 standard.

5.5 Operation of the fault contact



When the amplifier is working properly, the NO/NC relay is activated in the normally closed position: NC.

If the fault synthesis detects an operating problem (broken loop, wrong loop impedance, amplifier failure, etc.) the NO/NC relay is deactivated in the normally open position: NO.

5.6. Audio input

5.6.1 Sensitivity

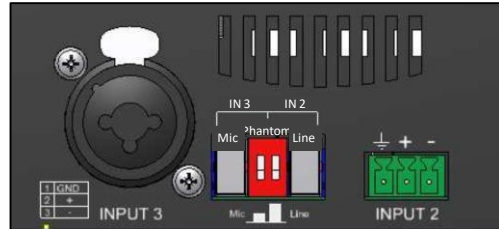

The level of INPUT 2 and INPUT 3 can be adjusted according to the audio source used.

- When the audio source connected to one of the inputs is a microphone, set the grey button to the Mic position.
- When the audio source connected to one of the inputs is line level, position the grey button released on the Line position.

5.6.2 Phantom power

The Phantom DIP switch on the rear panel of the amplifier (see previous figure) enables or disables phantom power for microphones that require voltage to operate.

When using a phantom power:

- If the audio source of the INPUT 2 and/or INPUT 3 is a microphone that needs voltage:
 - o The DIP switch must be up
- When the audio source of the INPUT 2 and/or INPUT 3 is a microphone does not require voltage:
 - o The DIP switch must be down
- If the audio source is music:
 - o The DIP switch must be down

6. Functioning and planning of a loop system

6.1 Preamble

A study revealed that more than 60% of the Magnetic Induction Loop installations do not work or work poorly, far from the requirements of the standard (IEC-60118-4). Indeed, the main difficulty lies in the implementation of the loop path. This observation led us to seek and provide effective solutions to meet this standard.

It is therefore important to carefully read the following instructions to ensure proper operation of the system and compliance with the IEC-60018-4 standard. Do not hesitate to contact your local distributor, we can help you with the study phase before the installation of the system.

6.2 Working principle

6.2.1 The magnetic field

When an alternating current flows through a copper cable, it generates a magnetic field.

The intensity of the magnetic field is directly related to the intensity of the electric current flowing in the cable.

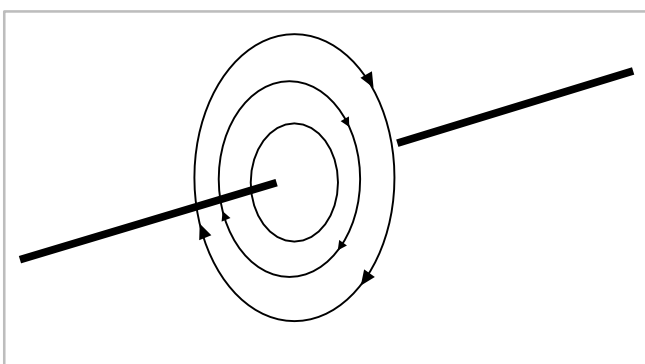
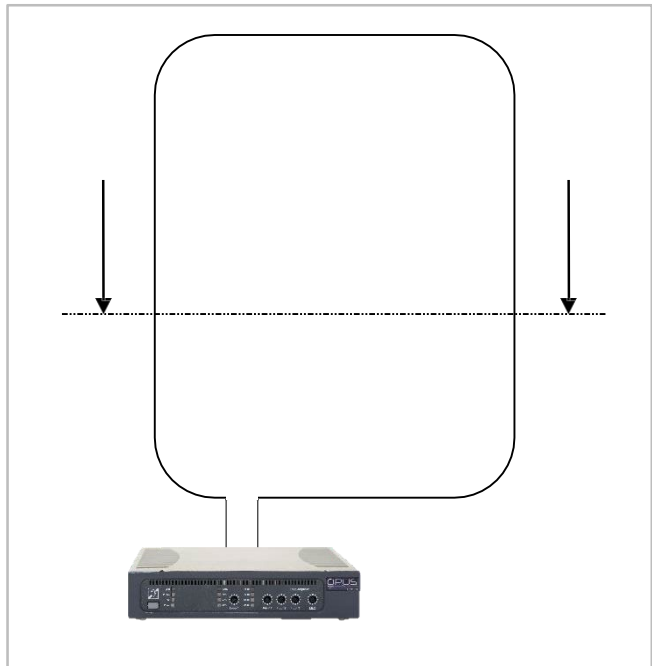

Illustration of an electromagnetic wave around a conductor - Figure 10

6.2.2 Magnetic field diffusion in a loop

When the intensity of the current flowing in a loop is adapted to the width of the room to be equipped, the radiation of this one makes it possible to cover the whole room.



Top view of a loop installation in a room - Figure 11

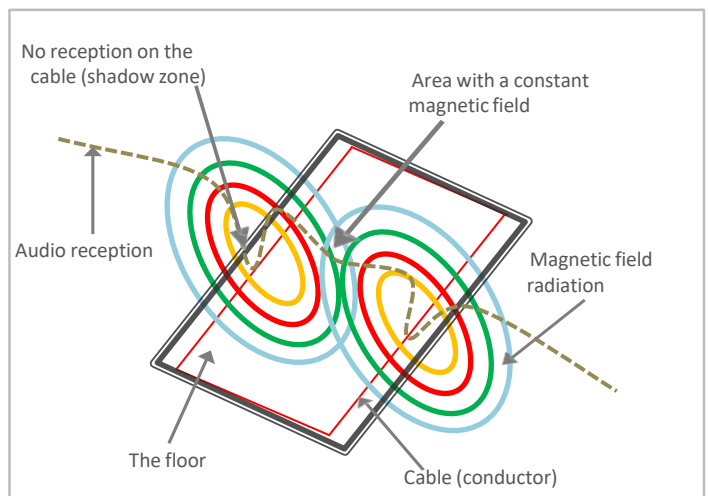

Sectional view of a loop installation in a room - Figure 12

6.2.3 System composition

A magnetic induction loop system is composed of :

- An amplifier
- One or more loops created with a conductor
- An audio signal (microphone or line)
- In some configurations a twisted pair cable (Opus references: OP-LI5/10 or 15).



Refer to figure 15

6.3 The different types of installation

6.3.1 Simple loop

A simple magnetic loop is composed of an amplifier and one or more induction loops.

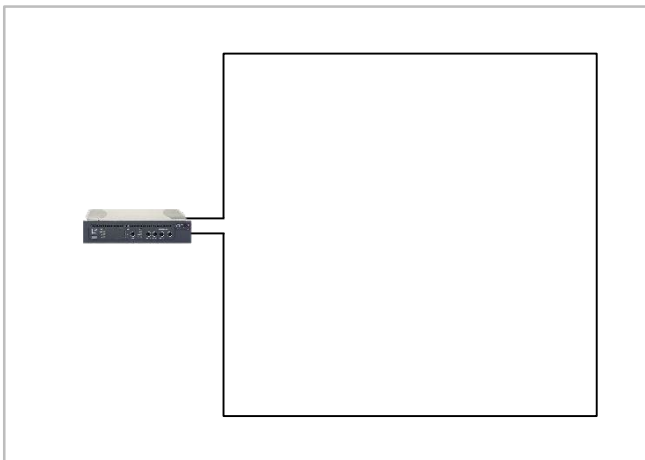

Installation of a simple loop - Figure 13

6.3.2 The simple 8 loop or phased array

In some configurations, it will be preferable to use an 8 loop rather than a single loop to generate a more intense magnetic field on the surface to be covered. This type of installation improves the coverage area.

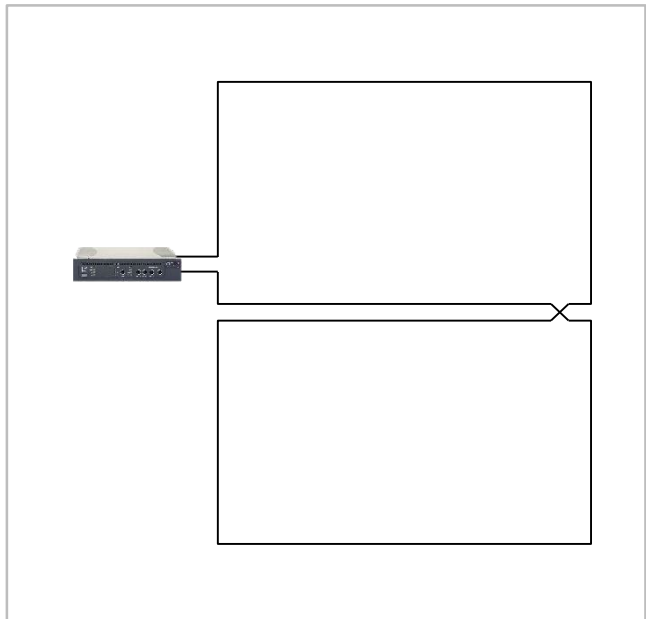

Installation of a simple 8 loop - Figure 14

Why the "8" loop?

- A magnetic loop in the shape of a number 8 allows to reduce the crosstalk of the magnetic field.
- It allows to cover a larger surface and to have a better homogeneity of coverage.
- The current required is less important, so the power consumption is also reduced.

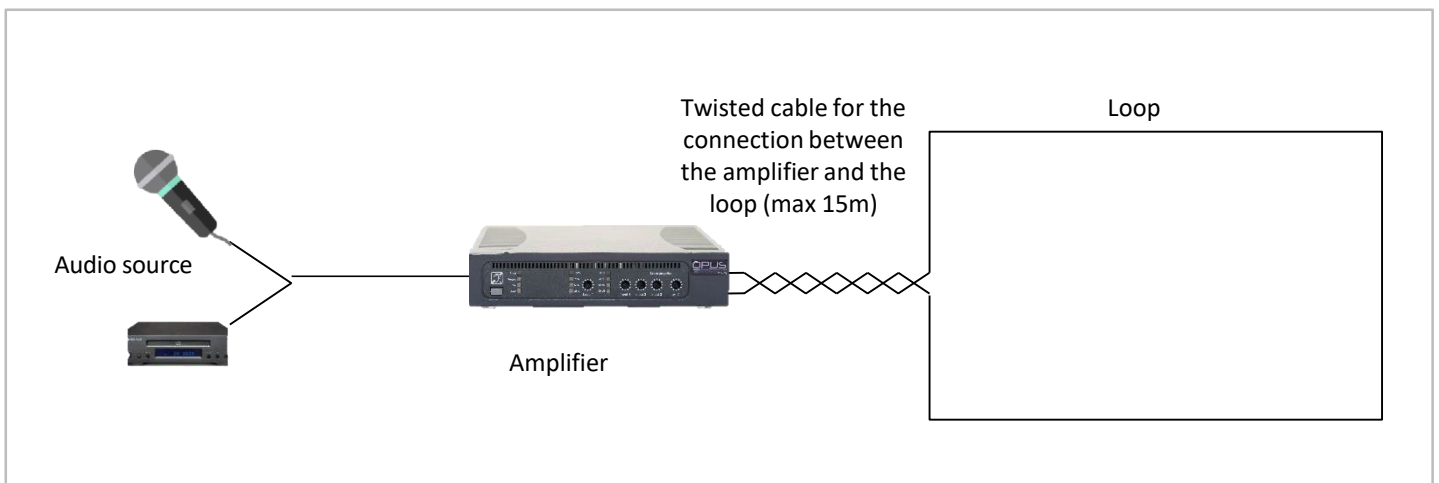
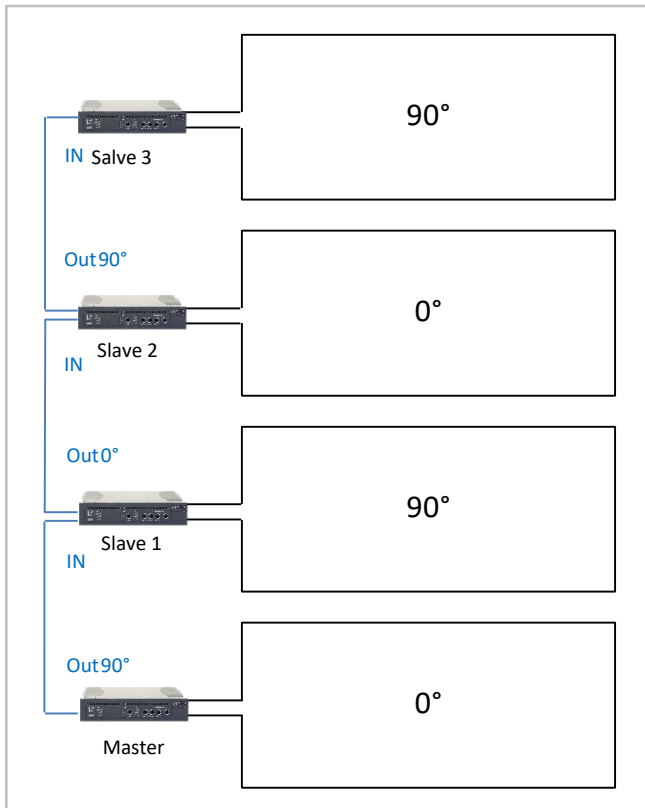

Illustration of a complete magnetic loop system - Figure 15

6.3.3 Simple phased loops

In order to allow a more extensive coverage in large spaces such as in an exhibition park, a sports hall or a zenith, it is possible to install several simple loops by using the input and the slave outputs.



Single loop installation - Figure 16



Refer to page 21 to view the connection between the amplifiers for this type of configuration.

6.3.4 Phased loops with low overflow

When several rooms are adjacent to each other (one next to each other or one on top of each other), it is important to take into account the external radiation of the magnetic field. Indeed, if the amplifier is adapted, a magnetic induction loop radiates perfectly in the desired zone but also outside this zone. Generally, the external coverage is equal to 4 times the width of the room. It is necessary to count 4 times the width to have a total isolation zone.

In order to respond appropriately to this type of problem, there is a type of installation that allows to contain the overspill to the strict dimension of the room. This type of installation also provides other advantages (see below).

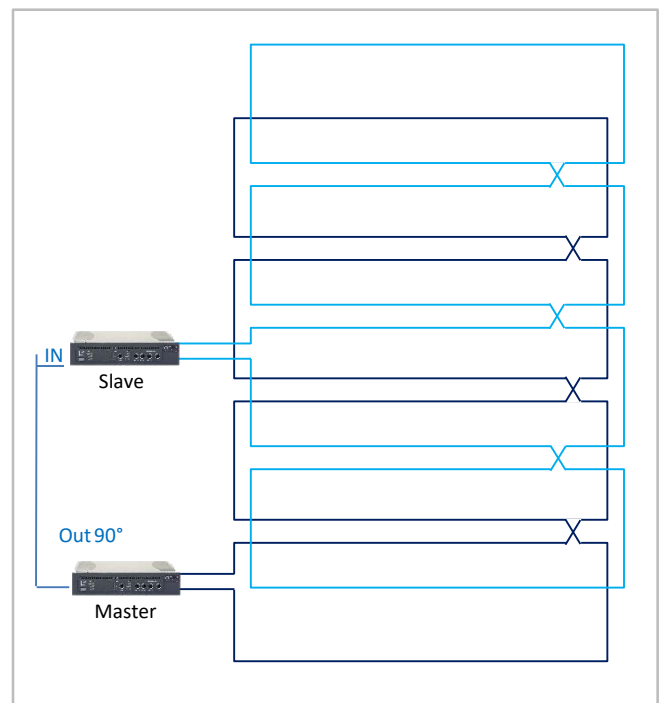

Installation of a phased loop system - Figure 17

Why install low overflow multi-loops?

- Suppression of magnetic field directivity (vertical and horizontal fields are transmitted).
- No attenuation in coverage.
- Reduced power consumption.
- Better signal reproduction.
- Reduced influence of metals.
- Reduced risk of feedback.
- Virtually no external radiation.

7. The magnetic induction loop

The installation of a magnetic induction loop is a complex exercise. To ensure that it works perfectly, it is important to take into account several essential parameters and to adapt its installation to the specificities of the room to be equipped.

The following points will help you maximizing the audio quality and minimize the variation of the magnetic field strength.

7.1 Installing your loop

To locate the best place for the loop it is important to determine the listening height (height of the human ear) in the area to be equipped. For example, in a conference room, people are seated, so the listening height is between 1.10m and 1.40m.

This position is very important to determine the power required and therefore the type of amplifier to be used to comply with the IEC-60118-4 installation standard. It is important to note that the coverage data of our amplifiers are announced with a loop installed on the ground and without disturbance.

Each project is different and must be studied before purchasing an amplifier. Opus Technologies has developed Smartloop, a simulation software, which allows to study each project according to the constraints.

7.2 Cable section

The direct current resistance depends on the diameter of the cable and its length. It should be between 0.5 and 3 Ω for optimal operation of the amplifiers. This result depends on the length of the cable and its section, you can use our simulation software Opus Smartloop or call your specialized distributor to know the usable sections according to the size for your project.

There are 2 types of cable for loop installation:

1. The copper foil to be installed under a lino, parquet, carpet, etc. Opus references: RC50/100/150
2. The classic flexible cable type H07RNF. However, in order to avoid wire impedance problems, Opus Technologies has developed a variable resistance cable which allows to ensure 90% of the loop installation needs and avoids cross section errors.

The Loop Cable (LC-50/100/150) offers a variation of sections from 0.5 to 2.5mm². See image below:



Loop Cable (ref : LC-50/100/150)

7.3 Connection

To connect the loop cable(s) to the amplifier, use a twisted cable to avoid unwanted inductions. We recommend not to move the amplifier more than 15 m from the loop.

7.4 The magnetic field

The strength of the magnetic field depends on the electric current impelled in the loop.

To meet the IEC-60118-4 standard, depending on the configuration of the room, 1.2m (for a seated person) or 1.70m (for a standing person) above the floor in the listening area equipped with a magnetic loop, the vertical fields must be 100 mA/m +/- 3 dB.

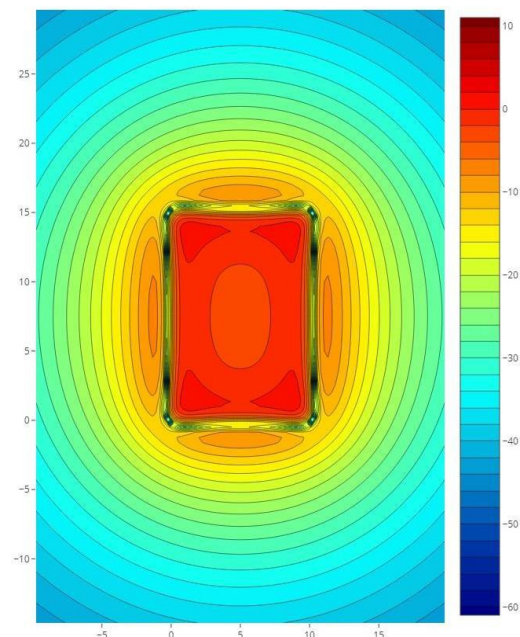

Magnetic field coverage simulation with Opus Smartloop software - Figure 18

7.5 Technical study

Presentation of magnetic field data for a 15x10m room. Data from our simulation tool Opus Smartloop.

7.5.1 Perimeter loop

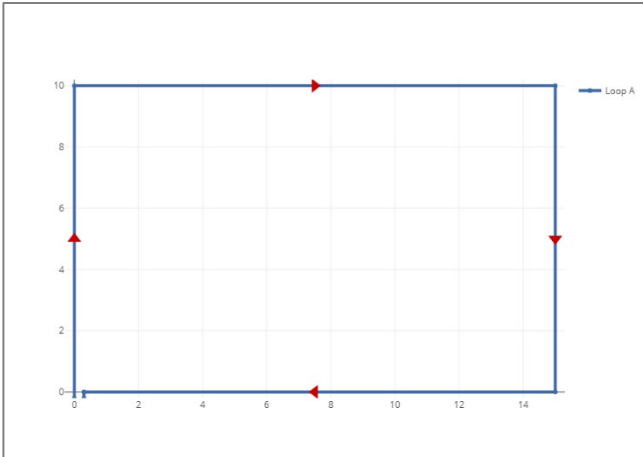

Simple loop installation

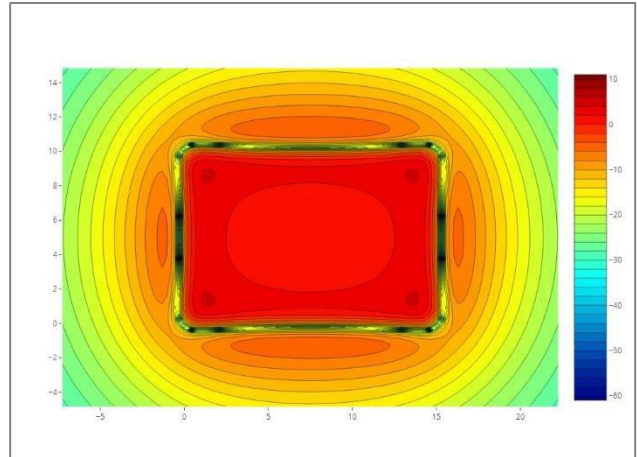

Simple loop 2D simulation

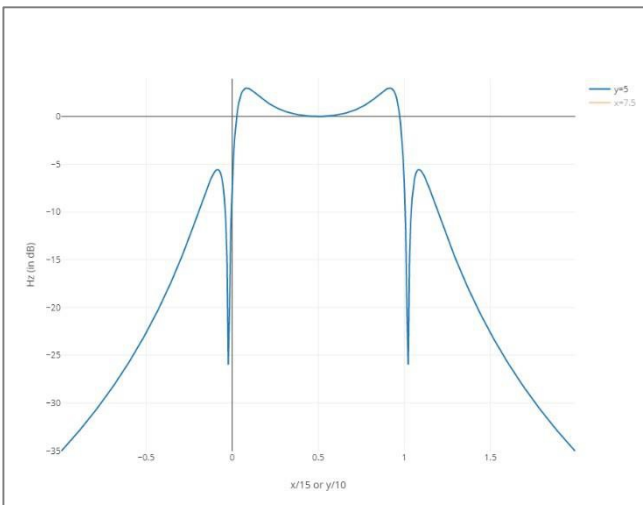

Simple loop median

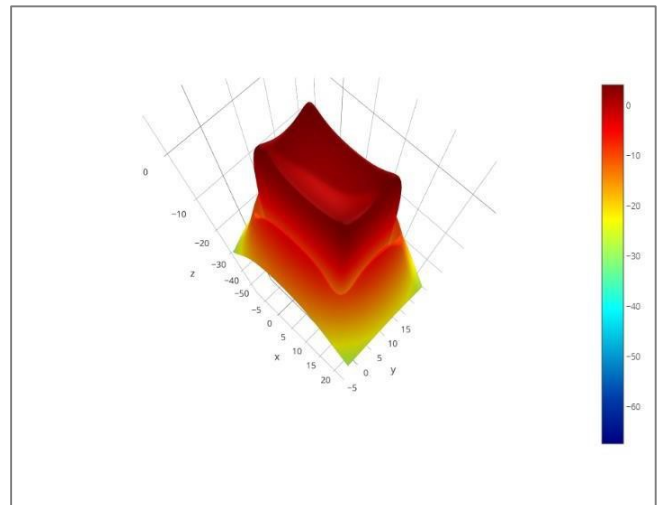

Simple loop 3D simulation

Liste des fils disponibles:

Longueur de la boucle A: 50m

Longueur de la boucle B: 0

Section de fil	Boucle de résistance A
0,5 mm ²	1.72500 Ω
1,0 mm ²	0.86250 Ω
1,5 mm ²	0.57500 Ω
2,5 mm ²	0.34500 Ω
4,0 mm ²	0.21563 Ω
Feuille de cuivre	0.45395 Ω

Table of cable sections

7.5 Technical study

Presentation of magnetic field data for a 15x10m room. Data from our simulation tool Opus Smartloop.

7.5.2 Cancellation loop

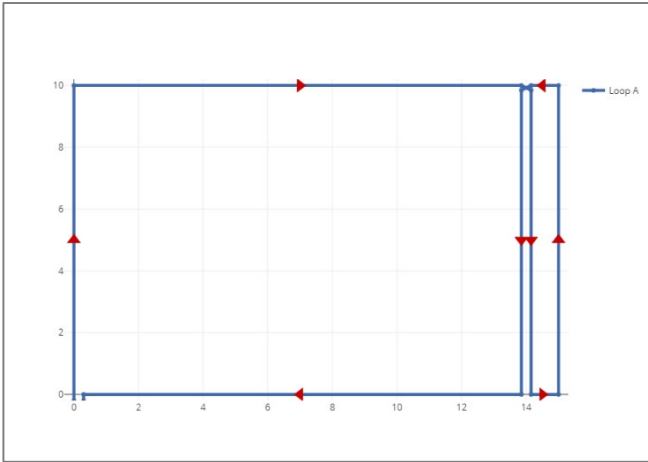

Cancellation loop installation

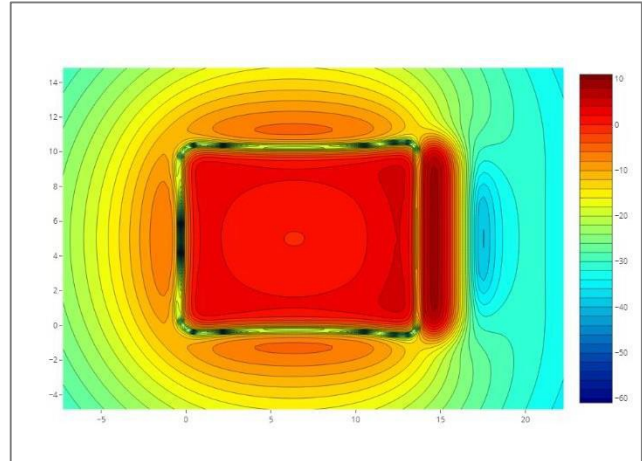

Cancellation loop 2D simulation

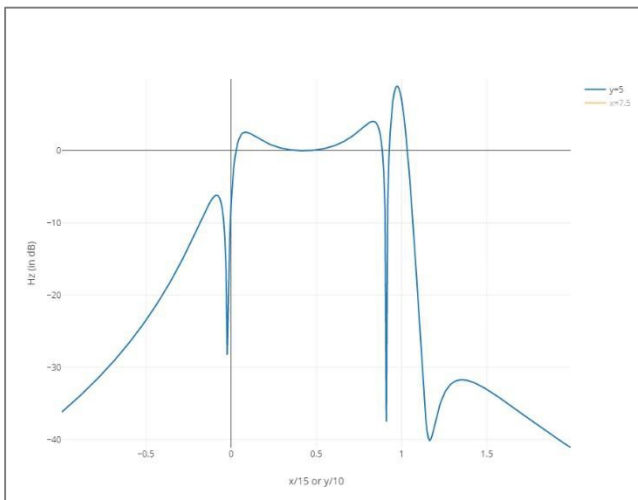

Cancellation loop median

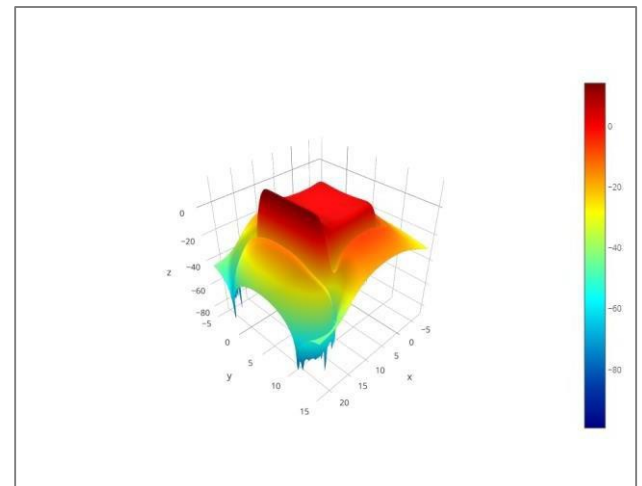

Cancellation loop 3D simulation

Liste des fils disponibles:

Longueur de la boucle A: 92m
Longueur de la boucle B: 0

Section de fil	Boucle de résistance A
0,5 mm ²	3.17400 Ω
1,0 mm ²	1,58700 Ω
1,5 mm ²	1,05800 Ω
2,5 mm ²	0,63480 Ω
4,0 mm ²	0,39675 Ω
Feuille de cuivre	0,83526 Ω

Table of cable sections

7.5 Technical study

Presentation of magnetic field data for a 15x10m room. Data from our simulation tool Opus Smartloop.

7.5.3 Ultra low overflow system

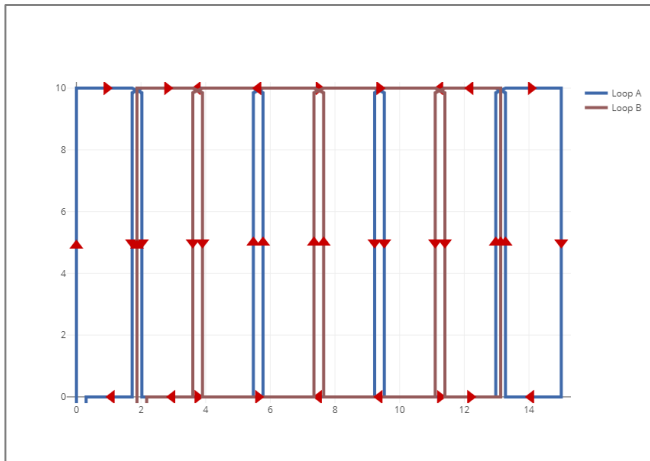

Ultra low overflow system installation

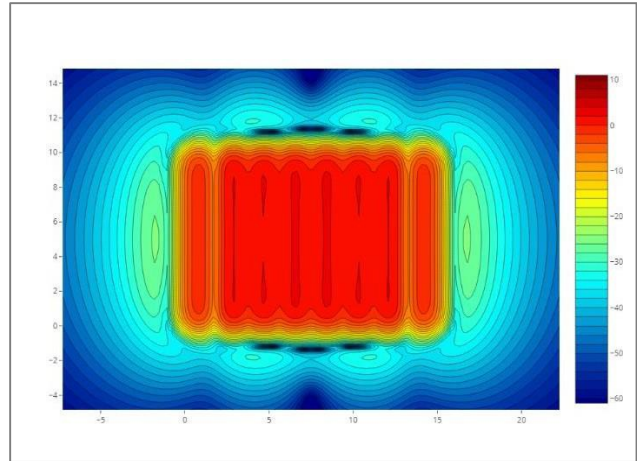

Ultra low overflow system 2D simulation

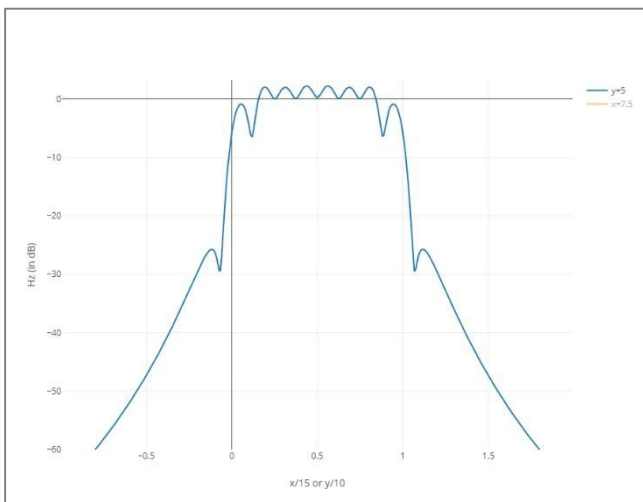

Ultra low overflow system median

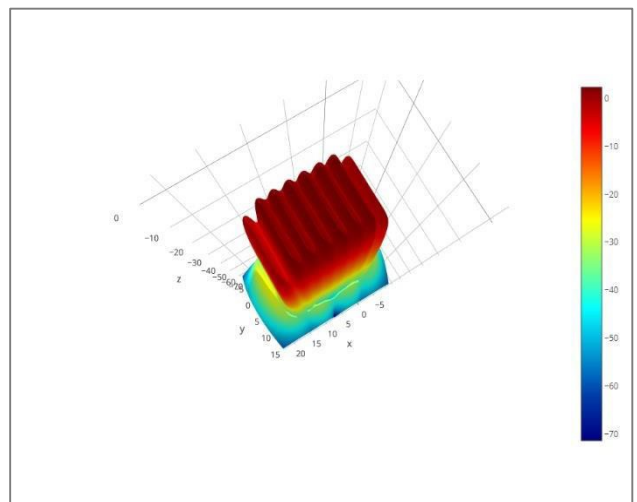

Ultra low overflow system 3D simulation

Liste des fils disponibles:

Longueur de la boucle A: 130m

Longueur de la boucle B: 102.5m

Section de fil	Boucle de résistance A	Boucle de résistance B
0,5 mm ²	4.48500 Ω	3.53625 Ω
1,0 mm ²	2.24250 Ω	1.76812 Ω
1,5 mm ²	1.49500 Ω	1.17875 Ω
2,5 mm ²	0.89700 Ω	0.70725 Ω
4,0 mm ²	0.56062 Ω	0.44203 Ω
Feuille de cuivre	1.18026 Ω	0.93059 Ω

Table of cable sections



In order to guarantee the compliance with the IEC-60018-4 standard during the installation of your magnetic induction loop, Opus Technologies and its local distributors will guide you in the study and installation of your project.

Visit <http://opus-technologies.fr/contact-us/> to find your local distributor or write to us.

8. Installation constraints

Some environments can create interference with the magnetic induction loops, here are the main causes.

8.1 Magnetic overspill

The installation of a perimeter loop system is perfectly suitable to cover a room if the amplifier is correctly sized, however it is important to note that the magnetic field of a loop will cover the inside of the room but also the outside. The larger the loop will be, the more radiation it will have (note: in principle, 4 times the width of a loop is needed to have a total isolation zone). This phenomenon of external radiation can be problematic when it is necessary to equip several contiguous rooms or for reasons of confidentiality.

To remedy this problem, it is possible to create low overflow installations that will avoid the radiation of the magnetic field. See paragraphs 6.3.3 and 7.5.3.

8.2 Metal distortion

Metal distorts the magnetic field at high frequencies. Many buildings contain metal, especially in their structures.

To limit the influence of metal we have created a tone compensation with the MLC (Metal Loss Compensation) setting on the front panel of the amplifiers.

9. Information

9.1. Maintenance and care

Opus Technologies amplifiers do not require any maintenance. If the unit becomes dirty, simply wipe it clean with a soft, damp cloth.

Note: Disconnect the LD series amplifier from the power supply first. Never use spirits, thinners or other organic solvents. Do not place the LD series amplifier where it will be exposed to full sunlight for long periods. In addition, it must be protected against excessive heat, moisture and severe mechanical shocks.

Note: This product is not protected against splash water. Do not place any containers filled with water, such as flower vases, or anything with an open flame, such as a lit candle, on or near the product.

When not used, store the device in a dry place, protected from dust.

9.2. Warranty

Opus Technologies amplifiers are manufactured in France according to strict specifications guaranteeing quality and reliability.

Should a malfunction occur despite the unit being set up and operated correctly, please contact your dealer or the manufacturer directly.

Opus Technologies products have been designed to meet the needs of the end user and to offer the best possible audio performance and reliability. The quality of manufacturing allows us to offer our customers a 5-year manufacturer's warranty.

This warranty covers the repair of the product and returning it to you free of charge. It is recommended that you send in the product in its original packaging, so keep the packaging for the duration of the warranty period. The warranty does not apply to damage caused by incorrect handling or attempts to repair the unit by people not authorised to do so (destruction of the product seal). Repairs will only be carried out under warranty if the completed warranty card is returned accompanied by a copy of the dealer's invoice/till receipt.

Always specify the product number in any event.

9.3 After-sales service and return

The Opus Technologies team is committed to providing fast and efficient after-sales service. In case of product malfunction you have to contact your local distributor or write us at contact@opus-technologies.fr.



9.4. Disposal of used electric and electronic units

(Applicable in the countries of the European Union and other European countries with a separate collection system).

The symbol on the product or the packaging indicates that this product is not to be handled as ordinary household waste but has to be returned to a collecting point for the recycling of electric and electronic units. You protect the environment and health of your fellow men by the correct disposal of this products. Environment and health are endangered by a faulty disposal. Material recycling helps to reduce the consumption of raw material. You will receive further information on the recycling of this product from your local community, your communal disposal company or your local reseller.

9.5. Technical specifications

	LD1.0	LD2.0	LD3.0
Coverage	250 m ² (10*25 m ²)	450 m ² (15*30 m ²)	1000 m ² (20*45 m ²)
Operating temperature	0 to +45°C	0 to +45°C	0 to +45°C
Storage temperature	-30 to +70°C	-30 to +70°C	-30 to +70°C
INPUT			
Audio inputs	3 inputs: x2 line/microphone, x1 100V	3 inputs: x2 line/microphone, x1 100V	3 inputs: x2 line/microphone, x1 100V
Connector type	Phoenix and/or Combo Neutrik	Phoenix and/or Combo Neutrik	Phoenix and/or Combo Neutrik
Phantom supply	12V 2mA	12V 2mA	12V 2mA
Sensitivity	-50dB microphone, +40dB 100V, -10dB line	-50dB microphone, +40dB 100V, -10dB line	-50dB microphone, +40dB 100V, -10dB line
Priority	100V input, INPUT 1	100V input, INPUT 1	100V input, INPUT 1
POWER SUPPLY			
Type	Integrated	Integrated	Integrated
Voltage	115/230V (automatic) 50/60 Hz	115/230V (automatic) 50/60 Hz	115/230V (automatic) 50/60 Hz
Nominal power consumption at 1 Ohm	25 W	50 W	90 W
Maximum input power	<250VA	<300VA	<350VA
Consumption at rest on connected loop	9W at 230V AC, 1 loop of 1 Ohm connected, at ambient temperature after 30 minutes of stabilization		
AUDIO CHARACTERISTICS			
THD	<0,5% @1ohm / 1KHz / nominal current	<0,5% @1ohm / 1KHz / nominal current	<0,5% @1ohm / 1KHz / nominal current
Automatic gain control	AGC optimized for speech Dynamic > 36dB	AGC optimized for speech Dynamic > 36dB	AGC optimized for speech Dynamic > 36dB
Bandwidth	80 Hz to 9,5 kHz at -3 dB	80 Hz to 9,5 kHz at -3 dB	80 Hz to 9,5 kHz at -3 dB

9.5. Technical specifications

	LD1.0	LD2.0	LD3.0
OUTPUT			
Loop impedance	0,5Ω à 3Ω	0,5Ω à 3Ω	0,5Ω à 3Ω
Output voltage	34V rms (48V pK)	34V rms (48V pK)	34V rms (48V pK)
Peak current	8A pK	11A pK	15A pK
RMS current	5A rms	7A rms	10A rms
Slave output	0° or 90° phase shift	0° or 90° phase shift	0° or 90° phase shift
ADDITIONAL FUNCTIONS			
LED display	« Power », « Protect », « Clip », « Loop »	« Power », « Protect », « Clip », « Loop »	« Power », « Protect », « Clip », « Loop »
Metal loss correction	0 to 3 dB per octave	0 to 3 dB per octave	0 to 3 dB per octave
Relay	NO/NC fault relay 0,5A/125Vac, 1A/24VDC	NO/NC fault relay 0,5A/125Vac, 1A/24VDC	NO/NC fault relay 0,5A/125Vac, 1A/24VDC
DIMENSIONS (MM)			
HxLxD	42 x 200 x 215 mm	42 x 200 x 215 mm	42 x 200 x 215 mm
Weight	1,48 kg	1,48 kg	1,48 kg



9.6. CE certification

This device complies with the following CE directives:

- 2017 / 2102 / CE RoHS-directive
- 2012 / 19 / CE WEEE-directive
- 2014 / 35 / CE Low voltage directive
- 2014 / 30 / CE Electromagnetic Compatibility

Compliance with the directives listed above is confirmed by the CE seal on the device. CE compliance declarations are available on the Internet at www.opus-technologies.fr.

Technical specifications are subject to change.

Declaration of Conformity



October 16, 2016 in Pessac

AUDIOFILS

9 Chemin de la Vieille Ferme

33650 MARTILLAC – France

Declares that the product :

LD Series : Induction Loop Amplifier

Complies with the following directive and norms :

EN55103-1:2009 + A1:2013 : Electromagnetic compatibility. Product family standard for audio, video, audio-visual and entertainment lighting control apparatus for professional use. Immunity

EN60065-1:2015 : Audio, video and similar electronic apparatus. Safety requirements :

EN 60118:2015 for a maximal coverage of 1000 sqm² :

Acoustics, hearing aid, acoustic frequency, magnetic field, field strength, measurement and characteristic.

RoHS Directive : 2011 / 65 / EC

The amplifier must be adjusted and connected according to the Opus Technologies instruction manual.

Lucas CASTELNAU

Manager Sales (AUDIOFILS)

AUDIOFILS SARI

9 Chemin de la Vieille Ferme
Bâtiment B
33650 MARTILLAC
Tel : 09 81 24 00 06 – Fax : 09 82 03 23 56
Mail : contact@audiofils.com – Site : www.audiofils.com
FR 17 720 768 661 - FR 17 68 461 00013

Pierre DELAGE

Manager Development (NEOSYSTEMES)



Certificat de conformité IEC 60118-4

Installation de boucle à induction magnétique pour malentendants



Informations Client	Informations sur l'installation
Client :	Installateur :
Salle :	Société :
Adresse :	Équipement :
	N° série :
	Testée par :

1 CROQUIS DE LASALLE													
<i>Dessiner la salle et la zone de couverture en indiquant les points de mesure et les bruits de fond</i>													

2 RECHERCHE DE BRUITS DE FOND ET INTERFÉRENCES		
<i>Amplificateur éteint et OP-FSM en position « -20dB ». Noter les interférences tolérables ou polluées sur le croquis</i>		
<i>Attention: L'existence de zones polluées par des bruits de fond compromet la conformité du système à la norme IEC60118-4</i>		
Zones à bruit acceptables > - 32 dB <input type="checkbox"/>	Zones à bruit tolérables > - 22 dB <input type="checkbox"/>	Zones polluées < - 22 dB <input type="checkbox"/>

3 EFFECTUER LES MESURES													
<i>Indiquer sur le croquis 6 à 8 points correspondants aux mesures effectuées assises (A) et debout (A1) à différents points de la salle.</i>													
<i>La norme stipule que la hauteur d'écoute est de 1.2m pour une place assise et 1.7m debout. Garder l'appareil de mesure toujours à la verticale.</i>													
Points de mesure		A	B	C	D	E	F	A1	B1	C1	D1	E1	F1
Champ magnétique (dB)	<i>Avant réglages avec bruit rose</i>												
Réponse en fréquences	100Hz												
	1KHz												
	5KHz												
Champ magnétique (dB)	<i>Après réglages avec audio</i>												

4 REGLAGE EFFECTUÉS	
<i>Dessiner ci-contre les réglages effectués sur l'amplificateur</i>	<input type="checkbox"/> Loop1 <input type="checkbox"/> Loop2 <input type="checkbox"/> Input1 <input type="checkbox"/> Input2 <input type="checkbox"/> Input3 <input type="checkbox"/> MLC

5 DERNIÈRES VÉRIFICATIONS	
<i>Une fois les tests effectués, le personnel du lieu équipé doit être informé et préparer à guider les malentendants dans l'utilisation du système.</i>	
<i>L'autocollant « oreille barrée T » doit être recollé et visible des visiteurs. Les cas contraires, l'installation ne pourra pas être déclarée conforme IEC60118-4</i>	

Personne formée :	Signalétique visible ? OUI <input type="checkbox"/> NON <input type="checkbox"/>
-------------------	---

Commentaires :

L'installation est conforme à la norme IEC60118-4

OUI NON

Nom :

Date :

Prénom :

Signature :

Couper le long des pointillés

For any additional questions, please contact us.

OPUS TECHNOLOGIES — ZI Lagrange II — 9 Chemin de la Vieille Ferme — 33650 MARTILLAC
Tel: (+33)09.81.24.00/06. — Fax: (+33)09.82.63.22.56. — contact@opus-technologies.fr

03/2021