



4K UHD
HDCP 2.2



MA-U42

4 x 2 HDMI Matrix with Amplifier & USB Hub

OPERATION MANUAL

HDMI®
HIGH-DEFINITION MULTIMEDIA INTERFACE

The terms HDMI, HDMI High-Definition Multimedia Interface, and the HDMI Logo are trademarks or registered trademarks of HDMI licensing Administrator, Inc.

DISCLAIMERS

The information in this manual has been carefully checked and is believed to be accurate. CYP (UK) Ltd assumes no responsibility for any infringements of patents or other rights of third parties which may result from its use.

CYP (UK) Ltd assumes no responsibility for any inaccuracies that may be contained in this document. CYP (UK) Ltd also makes no commitment to update or to keep current the information contained in this document.

CYP (UK) Ltd reserves the right to make improvements to this document and/or product at any time and without notice.

COPYRIGHT NOTICE

No part of this document may be reproduced, transmitted, transcribed, stored in a retrieval system, or any of its part translated into any language or computer file, in any form or by any means—electronic, mechanical, magnetic, optical, chemical, manual, or otherwise—without express written permission and consent from CYP (UK) Ltd.

© Copyright 2020 by CYP (UK) Ltd.

All Rights Reserved.

Version 1.1

TRADEMARK ACKNOWLEDGMENTS

All products or service names mentioned in this document may be trademarks of the companies with which they are associated.



SAFETY PRECAUTIONS

Please read all instructions before attempting to unpack, install or operate this equipment and before connecting the power supply.

Please keep the following in mind as you unpack and install this equipment:

- Always follow basic safety precautions to reduce the risk of fire, electrical shock and injury to persons.
- To prevent fire or shock hazard, do not expose the unit to rain, moisture or install this product near water.
- Never spill liquid of any kind on or into this product.
- Never push an object of any kind into this product through any openings or empty slots in the unit, as you may damage parts inside the unit.
- Do not attach the power supply cabling to building surfaces.
- Use only the supplied power supply unit (PSU). Do not use the PSU if it is damaged.
- Do not allow anything to rest on the power cabling or allow any weight to be placed upon it or any person walk on it.
- To protect the unit from overheating, do not block any vents or openings in the unit housing that provide ventilation and allow for sufficient space for air to circulate around the unit.

REVISION HISTORY

VERSION NO.	DATE	SUMMARY OF CHANGE
v1.00	26/02/2020	Preliminary release

CONTENTS

1. Introduction	1
2. Applications	2
3. Package Contents	2
4. System Requirements	2
5. Features	3
6. Operation Controls and Functions	4
6.1 Front Panel	4
6.2 Rear Panel	5
6.3 RS-232 Pinout and Defaults	7
6.4 WebGUI Control	7
6.4.1 Video Select Tab	10
6.4.2 EDID Tab	12
6.4.3 HDCP Tab	14
6.4.4 Audio Select Tab	15
6.4.5 Trigger Tab	18
6.4.6 System Tab	19
6.5 Telnet Control	21
6.6 Serial and Telnet Commands	21
7. Connection Diagram	43
8. Specifications	44
8.1 Technical Specifications	44
8.2 Video Specifications	45
8.3 Audio Specifications	47
8.3.1 Digital Audio	47
8.3.2 Analogue Audio	48
8.4 Cable Specifications	49
9. Acronyms	50



1. INTRODUCTION

This 4 by 2 matrix switch with amplifier is designed for use in environments needing a wide range of flexibility when it comes to inputs, outputs, and control. The three most common video input interfaces (HDMI, DisplayPort, and VGA w/stereo audio) are included along with a pair of HDMI outputs, providing the ultimate in source compatibility and flexibility. This unit is HDCP 2.2 compliant and supports resolutions up to a maximum of 4K@60Hz (4:4:4, 8-bit) for HDMI and Display ports. The included microphone input, with optional 48V phantom power and support for automatic ducking, feeds directly into a DSP mixer, allowing for powerful presentations with live voiceovers or even an impromptu karaoke session. Pass-through of multiple digital audio formats such as LPCM (up to 8 channels), bitstream and HD bitstream are supported. Additionally, the integrated stereo amplifier provides up to 40 watts of power (20W per channel) for local speakers to output the audio from the selected source, offering a flexible sound experience (LPCM 2.0 sources only).

This matrix also includes a USB 3.0 hub with one host port (Type-B), plus three device ports (Type-A) for a flexible KVM configuration. It also provides an interface for a remote control keypad or trigger interface, which can be easily installed within a podium or table making this matrix ideal for use in meeting rooms, classrooms, and auditoriums which need comprehensive video and audio integration with USB expansion. This unit is controllable via front panel controls, WebGUI, Telnet, Triggers, and RS-232.

2. APPLICATIONS

- /// Lecture room display and control
- /// Showroom display and control
- /// Meeting room presentation and control
- /// Classroom display and control

3. PACKAGE CONTENTS

- /// 1× UHD⁺ Multi-Format HDMI Switcher with Amplifier
- /// 1× 24V/3.75A DC Power Adapter
- /// 1× Power Cord
- /// 2× 5-pin Terminal Block
- /// 1× 3-pin Terminal Block
- /// 2× 2-pin Terminal Block
- /// 1× Shockproof Feet (Set of 4)
- /// 1× Operation Manual

4. SYSTEM REQUIREMENTS

- /// HDMI, DisplayPort, or VGA source equipment such as media players, video game consoles, PCs, or set-top boxes.
- /// HDMI receiving equipment such as HDTVs, monitors or audio amplifiers.
- /// The use of Premium High Speed HDMI cables is highly recommended.

5. FEATURES

- /// HDMI 2.0 and DVI 1.0 compliant
- /// HDCP 1.x and 2.2 compliant
- /// 4 video inputs (2×HDMI, 1×DisplayPort, 1×VGA w/ analogue audio)
- /// 2 matrixed HDMI outputs
- /// HDMI and DisplayPort inputs support resolutions up to 4K@60Hz (4:4:4, 8-bit)
- /// VGA input supports resolutions up to 1080p60Hz
- /// HDMI outputs support resolutions up to 4K@60Hz (4:4:4, 8-bit)
- /// Supports Deep Colour input and output up to 12-bit (HDMI/DisplayPort only)
- /// Supports 10-bit and 12-bit HDR (High Dynamic Range) input/output (HDMI/DisplayPort only)
- /// Supports pass-through of 8 channel LPCM, bitstream & HD bitstream audio formats
- /// Audio mixer function allows the mixing of audio from any LPCM 2.0 audio source with the microphone input
- /// Microphone input supports 48V phantom power and feeds into a DSP mixer allowing adjustable mix levels, automatic ducking, audio output mixing, volume, and mute controls
- /// High performance, 2 channel, class D amplifier with 20 watts of power per channel and independent volume control
- /// USB 3.0 hub with one host port (Type-B) and three device ports (Type-A)
- /// Trigger Control Keypad support for easy, single-button, function activation (Optional)
- /// Comprehensive EDID and HDCP management
- /// Controllable via front panel controls, RS-232, Telnet, WebGUI, and triggers

6. OPERATION CONTROLS AND FUNCTIONS

6.1 Front Panel

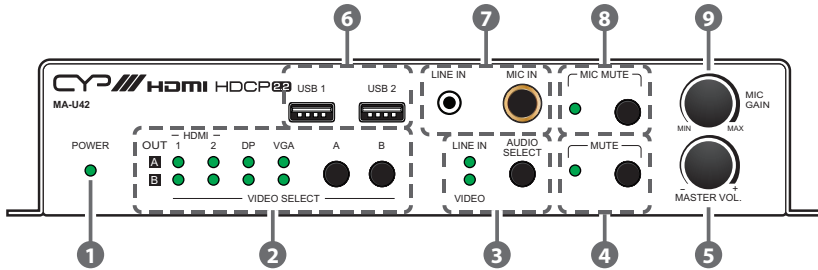

- 1 POWER LED:** This LED will illuminate to indicate the unit is on and receiving power.
- 2 VIDEO SELECT Buttons & LEDs:** Press the A and B buttons to sequentially switch through the available inputs for each of the two HDMI outputs. The OUT A/B LEDs will illuminate to indicate which source is currently selected for each output.
- 3 AUDIO SELECT Button & LEDs:** Press this button to toggle between the front panel Line Input and Output A's currently selected video's native audio as the source route to Output A and the analogue audio outputs. The LED will illuminate to indicate which source is currently selected.

Note: When Mic In has been selected via the WebGUI, both LEDs will remain off.
- 4 MUTE Button & LED:** Press to toggle between muting or unmuting all primary audio sources on Output A and the analogue outputs. The LED will illuminate to indicate that mute is active.

Note: Microphone sourced audio and the audio on output B is not affected by this setting.
- 5 MASTER VOL. Knob:** Turn this knob to increase or decrease the audio volume level of both analogue outputs as well as HDMI output A.

Note: This control is only active when the volume control toggle is set to "Panel" in the WebGUI.

- 6 USB 3.0 Device Ports 1 & 2 (Type-A):** Connect directly to standard USB devices such as a mouse, keyboard or flash drive to extend their USB functionality to the host connected to the USB 3.0 Host Port.
- 7 LINE IN Port:** Connect to the stereo analogue output of a device such as an audio player or PC.

MIC IN Port: Connect to a standard microphone using a 6.35mm plug.

Note: If the microphone requires 48V phantom power, that setting must be activated within the WebGUI.
- 8 MIC MUTE Button & LED:** Press to toggle between muting and unmuting microphone-sourced audio output. The LED will illuminate to indicate that mute is active.
- 9 MIC GAIN Knob:** Turn this knob to manually set the microphone input's gain level. Gain level is directly related to the knob's position.

Note: This control is only active when the volume control toggle is set to "Panel" in the WebGUI.

6.2 Rear Panel

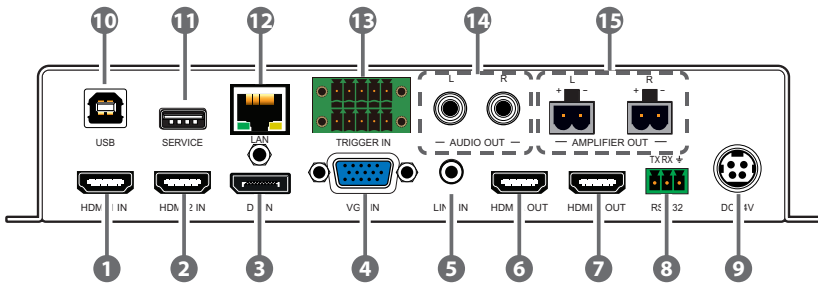

- 1 HDMI 1 IN Port:** Connect to HDMI source equipment such as a media player, game console, or set-top box.
- 2 HDMI 2 IN Port:** Connect to HDMI source equipment such as a media player, game console, or set-top box.
- 3 DP IN Port:** Connect to DisplayPort source equipment such as a media player, PC, or set-top box.
- 4 VGA IN Port:** Connect to VGA source equipment such as a PC or laptop.

- 5 **LINE IN Port:** Connect to the stereo analogue output of the device connected to the VGA input port.
- 6 **HDMI A OUT Port:** Connect to an HDMI TV, monitor, or amplifier for digital video and audio output.
- 7 **HDMI B OUT Port:** Connect to an HDMI TV, monitor, or amplifier for digital video and audio output.

Note: Audio on this output is not controllable and is bypass only.

- 8 **RS-232 CONSOLE 3-pin Terminal Block:** Connect directly to a PC, laptop, or other serial control device with a 3-pin adapter cable to send RS-232 commands to control the unit.
- 9 **DC 24V Port:** Plug the 24V DC power adapter into this port and connect it to an AC wall outlet for power.
- 10 **USB 3.0 Host Port (Type-B):** Connect directly to a standard USB host such as a PC or laptop to extend their USB functionality to all currently connected USB devices.
- 11 **SERVICE Port:** Connect directly to a standard USB device such as a mouse, keyboard or flash drive to extend their USB functionality to the currently active USB Host Port. This port may also be used to apply firmware updates.
- 12 **LAN Port:** Connect directly, or through a network switch, to your PC/ laptop to control the unit via Telnet/WebGUI.
- 13 **TRIGGER IN 10-pin Terminal Block:** Connect to the Trigger Control Keypad (OPTIONAL) or any device with trigger switch functionality such as window security alarms, motion detectors, door switches, etc. Each of the 8 triggers will activate an assigned unit function when triggered.

Note: A minimum of 5V DC is required to activate a trigger

- 14 **AUDIO OUT R & L Ports:** Outputs audio extracted from Output A's current source (LPCM 2.0 sources only). Connect to powered speakers or an amplifier for stereo analogue audio output.
- 15 **AMPLIFIER OUT R & L 2-pin Terminal Blocks:** Connect to unpowered 4Ω speakers for analogue stereo audio output. Up to 20W of power is provided to each speaker.

6.3 RS-232 Pinout and Defaults

Serial Port Default Settings	
Baud Rate	19200
Data Bits	8
Parity Bits	None
Stop Bits	1
Flow Control	None

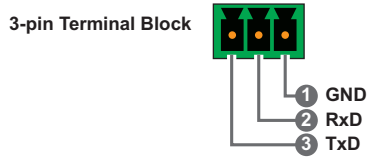

6.4 WebGUI Control

Device Discovery

Please obtain the “Device Discovery” software from your authorised dealer and save it in a directory where you can easily find it.

Connect the unit and your PC/Laptop to the same active network and execute the “Device Discovery” software. Click on “Find Devices on Internet” and a list of devices connected to the local network will show up indicating their current IP address.

Note: The unit’s default IP address is 192.168.1.50.

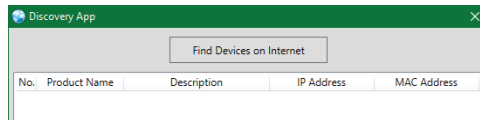

By clicking on one of the listed devices you will be presented with the network details of that particular device.

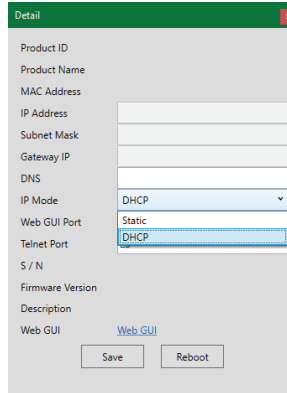

The screenshot shows a 'Detail' configuration window with the following fields and options:

- Product ID
- Product Name
- MAC Address
- IP Address
- Subnet Mask
- Gateway IP
- DNS
- IP Mode: DHCP (selected in a dropdown menu)
- Web GUI Port: Static
- Telnet Port: DHCP (selected in a dropdown menu)
- S / N
- Firmware Version
- Description
- Web GUI: [Web GUI](#)
- Buttons: Save, Reboot

- 1) IP Mode:** If you choose, you can alter the static IP network settings for the device, or switch the unit into DHCP mode to automatically obtain proper network settings from a local DHCP server. To switch to DHCP mode, please select DHCP from the IP mode drop-down, then click "Save" followed by "Reboot".
- 2) WebGUI Hotkey:** Once you are satisfied with the network settings, you may use them to connect via Telnet or WebGUI. The network information window provides a convenient link to launch the WebGUI directly.

WebGUI Overview

After connecting to the WebGUI's address in a web browser, the login screen will appear. Please enter the appropriate user name and password then click "Submit" to log in.

Note: The default user name and password is "admin".

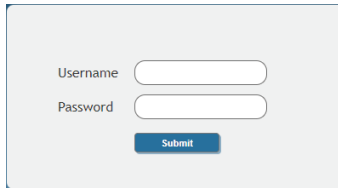

A screenshot of a login form with a light gray background. It contains two text input fields: the first is labeled "Username" and the second is labeled "Password". Below the "Password" field is a blue button with the text "Submit" in white.

On the left side of the browser you will see the following menu tabs where all primary functions of the unit are controllable via the built in WebGUI. The individual functions will be introduced in the following sections.

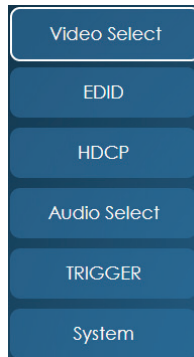

Clicking the red "Logout" tab will automatically log the currently connected user out of the WebGUI and return to login page.

6.4.1 Video Select Tab

This tab provides A/V routing control, auto switch controls, I/O renaming options and preset controls.

To begin assigning a new video route, please click an output button and then click on the button of the preferred input port. As you select each button they will change their colour to orange. The new route will become active immediately after selecting the input port and the routing information displayed on the buttons will change accordingly.

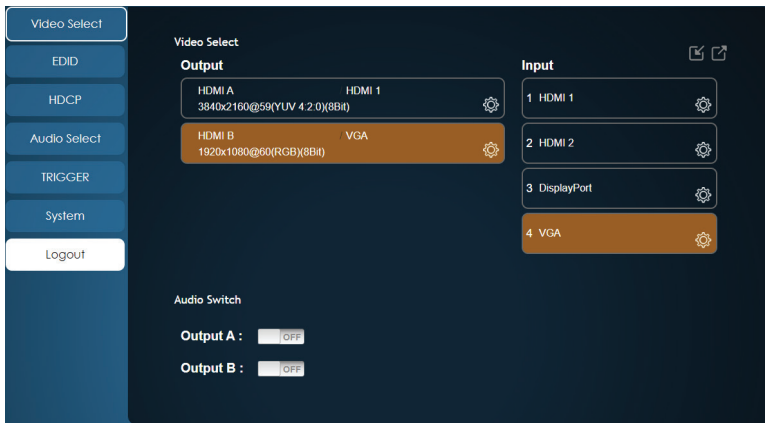

1) Video Select:

- **Output:** Buttons for selecting the output (A or B) to route A/V inputs to. Details about the output names and currently selected input are also displayed here. Clicking on the “edit” icon (✎) opens up the Edit Output window which allows for changing the output’s name.
- **Input:** Buttons for selecting the input (1 through 4) to route to the selected output. The current input names are also displayed here. Clicking on the “edit” icon (✎) opens up the Edit Input window which allows for changing the input’s name.

- 2) **Auto Switch:** Auto switching may be enabled or disabled individually for each output. Click on the On/Off slider to toggle the behavior of the selected output.

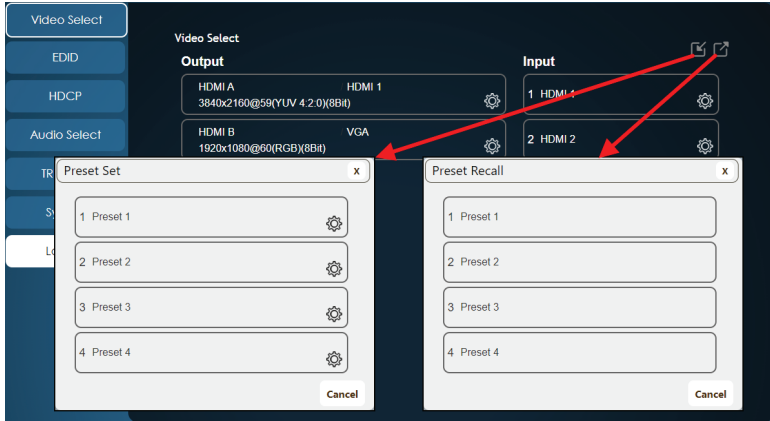

This unit can store up to four routing presets. Presets can be utilised to store multiple different routing states in advance for rapid, hassle-free, recall.

- 3) **Preset Set:** Once you have the routing set the way you like, you can click the "Preset Set" icon (⚙️) in the upper right corner of the tab to open the Preset Set window. Click on the preferred Preset button when you are ready to commit the preset to memory. You may also rename the preset at this stage by selecting the "edit" icon (✎️).
- 4) **Preset Recall:** When you wish to load a previously stored preset, please click the "Preset Recall" icon (⚙️) and you will be presented with a choice of the available 4 presets. The preset will load immediately upon selecting the button.

6.4.2 EDID Tab

This tab provides the option of six standard EDIDs, two sink sourced EDIDs and four customer uploaded User EDIDs that can be assigned to any or all of the HDMI/DisplayPort input ports.

1) Customer EDID Settings:

- **Save Name:** To modify the name of a User EDID, simply type the new name in the space provided and then click on the “Save Name” button to confirm the change.
- **Upload:** To upload a User EDID, press the “Upload” button next to the User EDID slot you wish to upload into. An EDID Upload window will appear, allowing you to locate and upload the preferred EDID file (*.bin format) from a local PC. Once the correct file has been selected, please click the “Upload” button in the window, and the file will be transferred to the unit.
- **Download:** To save an existing User EDID to your local PC, press the “Download” button next to the User EDID slot you wish to save. Depending on your browser settings you will either be asked where to save the downloaded file, or the file will be transferred to the default download location on your PC.

- 2) **Sink EDID Download:** To save the EDID from a connected display to your local PC, select the sink from the dropdown list then press the “Download” button. Depending on your browser settings you will either be asked where to save the downloaded file, or the file will be transferred to the default download location on your PC.
- 2) **Set EDID All:** Use the dropdown to select a single EDID to be assigned to all inputs simultaneously. Click the “Save” button to initiate the change.
- 3) **Set EDID Input Content/EDID Source:** The Set EDID Input Content section allows for the assignment of a specific EDID to any supported input port. Click on one or more input buttons on the left and then select the new EDID source to use from the choices on the right. The buttons will change colour as you select them and the EDID change will occur immediately across all selected inputs.

Note: In most cases, assigning a new EDID to an input will cause the affected input to briefly blink out while the source adapts to the new information.

This unit provides the following 6 default EDIDs:

Unit's Default EDIDs	
FHD 2CH	1920x 1090p@60Hz (148MHz) & 8-bit colour, LPCM 2.0
FHD MCH	1920x 1090p@60Hz (148MHz) & 8-bit colour, LPCM 7.1 & Bitstream
UHD 2CH	3840x 2160p@30Hz (297MHz) & Deep Colour (8/10/12-bit), LPCM 2.0
UHD MCH	3840x 2160p@30Hz (297MHz) & Deep Colour (8/10/12-bit), LPCM 7.1 & Bitstream
UHD+ 2CH	3840x 2160p@60Hz (594MHz) & Deep Colour (8/10/12-bit), LPCM 2.0
UHD+ MCH	3840x 2160p@60Hz (594MHz) & Deep Colour (8/10/12-bit), LPCM 7.1 & Bitstream

Note: In some rare cases it is possible for custom or external EDIDs to cause compatibility issues with certain sources. If this happens, it is recommended to switch to one of the 6 default EDIDs for maximum compatibility.

6.4.3 HDCP Tab

This tab provides the option of three HDCP operational modes that can be assigned to any or all of the HDMI/DisplayPort input ports.

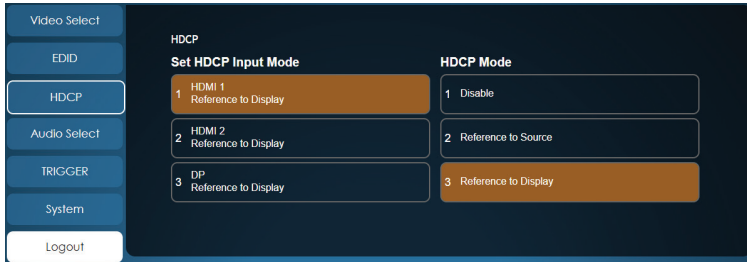

1) **Set HDCP Input Mode/HDCP Mode:** This section allows for the assignment of a specific HDCP behavior to any supported input port. Click on one or more input buttons on the left and then select the new HDCP mode to use from the choices on the right. The buttons will change colour as you select them and the change in HDCP behavior will occur immediately across all selected Inputs.

- **Reference to Source:** Makes the input operate using the HDCP version required by the connected source.
- **Reference to Display:** Limits the input to only accept the HDCP version supported by the connected display.
- **Disable:** Completely disables HDCP support on that input.

6.4.4 Audio Select Tab

This tab provides control over which audio is routed to Output A and the analogue audio outputs as well as providing control over audio mixing, analogue I/O volume and the microphone’s phantom power voltage.

Note: HDMI output B’s audio is always a direct pass-through from the selected source and is not affected by the controls on this tab.



1) **Audio Select:** The audio routed to Output A and the analogue audio outputs is selected in this section. All changes are enacted immediately.

■ **Set Audio Mode:** Select the preferred audio content to output.

Note: When mixer mode is enabled, the selected source will be mixed with the microphone’s audio.

2) Volume: This section provides controls for adjusting the volume levels of the microphone input, the various audio sources when the mixer is enabled, as well as providing control over the amplified analogue output.

- **Microphone:** Allows the adjustment of the microphone input's volume level. The available adjustment range is 0(-35dB) to 100(+60dB).

Note: This control is greyed out and disabled when the toggle switch is set to "Panel".

- **Master Volume:** Allows the adjustment of the currently selected audio source's volume. The available adjustment range is 0(-80dB) to 100(+20dB).

Note: Only LPCM 2.0 audio is supported and bitstream audio will be automatically muted when the mixer is enabled. This control is greyed out and disabled when the toggle switch is set to "Panel".

- **Unmute/Mute Toggle:** This toggle switch controls muting the selected audio source over Output A and the analogue outputs.
- **Web/Panel Toggle:** This toggle switch controls if the microphone and master volume levels are controlled by the WebGUI (select "WEB") or by the volume knobs on the front of the unit (select "PANEL").

- **AMP L/R Gain:** Allows the adjustment of the amplifier's gain level. The available adjustment range is 0(-80dB) to 100(+20dB).

- **Source PreGain:** Allows the adjustment of Output A's currently selected video source's audio pre-gain level. The available adjustment range is 0(-80dB) to 100(+20dB).

Note: Only LPCM 2.0 audio is supported and bitstream audio will be automatically muted when the mixer is enabled.

- **Line In PreGain:** Allows the adjustment of the line audio pre-gain level. The available adjustment range is 0(-80dB) to 100(+20dB).

3) Phantom Power: Select the phantom power voltage level for the microphone port. Selecting 0V disables phantom power.

Note: After selecting a new voltage level, the WebGUI requires confirmation of the change before the new voltage will be used to avoid potential damage to a connected microphone that doesn't support phantom power.

4) **Audio Signal Detect:** This section provides controls for adjusting the mixer and talk over functionality. All changes are enacted immediately.

- **Mixer Toggle:** This switch enables or disables the unit's mixer mode. When the mixer is enabled, the currently selected "Audio Mode" source will be mixed with audio from the microphone input following the settings within this section.

Note: Only LPCM 2.0 audio is supported and bitstream audio will be automatically muted when the mixer is enabled.

- **Talk Over Toggle:** This switch enables or disables the unit's talk over mode which allows finer control over how the microphone input is handled.

Note: When talk over mode is disabled, or the mixer is disabled, the below settings will be greyed out.

- **Signal Detect:** Adjust the microphone's signal detection threshold. The talk over will be activated when the microphone's signal is over the threshold and lasting longer than the trigger time. The available adjustment range is -60dB to -10dB.
- **Trigger Time:** Adjusts the length of time a signal must be over the current signal detection threshold in order to trigger the microphone talk over function. The available adjustment range is 0 to 20 seconds.
- **Attack Time:** Adjusts the mixer attack time, the length of time used fading the microphone's audio into the output mix. The available adjustment range is 0 to 20 seconds.
- **Hold Time:** Adjusts the length of time to wait, when no audio over the threshold level is detected, before beginning to release the talk over mix. The available adjustment range is 0 to 20 seconds.
- **Release Time:** Adjusts the mixer release time, the length of time used fading the microphone's audio out of the output mix. The available adjustment range is 0 to 20 seconds.
- **Depth:** Adjusts the amount the primary audio source's volume level will be decreased when the talk over mix is activated. The available adjustment range is 0 to 100%.
- **Reset Button:** Press to reset all Audio Signal Detect settings to their factory defaults.

6.4.5 Trigger Tab

This tab allows the user to define the action assigned to each Trigger pin. Trigger assignments may also be tested here.

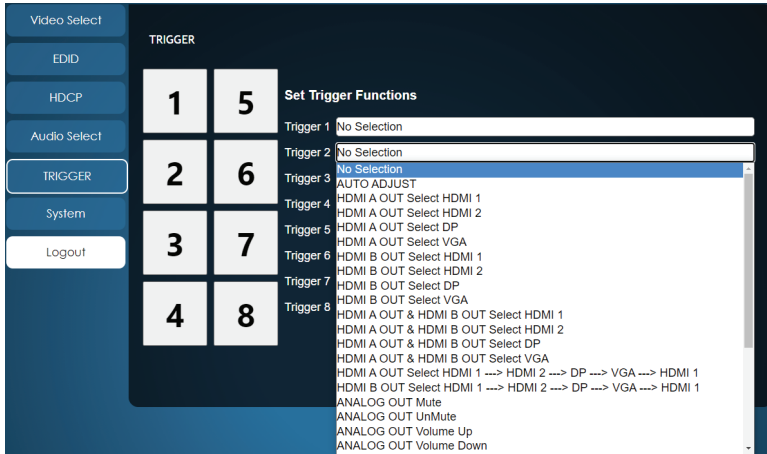

- 1) **Set Trigger Input:** Click on the dropdown next to each trigger number to assign a unit function or behavior to that trigger. If the selected function indicates a progression, then each activation of the trigger will move sequentially to the next item in the progression list.
- 2) **Trigger Test Keypad:** Click on any of the large numbered buttons on the left side of the tab to test the assigned function for each trigger.

6.4.6 System Tab

This tab provides system information, network configuration options, system configuration resets, and a firmware update function.

1) System:

- **Web User Setting:** This section provides a way to change the username and password for the Administrator account. Click on “Save” to confirm and activate any changes made to these settings.

Note: The default username and password is “admin”.

- **Network:** The unit’s IP mode may be switched between Static IP or DHCP. In Static IP mode the IP, netmask and gateway addresses may be manually set. When in DHCP mode, the unit will attempt to connect to a local DHCP server and obtain IP, netmask and gateway addresses automatically. Please press “Save” after making any changes to the IP configuration or mode.

Note: If the IP address is changed then the IP address required for WebGUI/Telnet access will also change accordingly.

- **Reset to Default:** Press the “Routing Reset” button to reset all I/O routing configurations to the factory defaults. Press the “Factory Reset” button to reset the unit to its factory default state. After the factory reset is complete, the unit will reboot automatically.

- **Web Login Timeout:** Select the length of time to wait before logging the user out of the WebGUI due to inactivity. Available range is from 1 to 65535 minutes. Setting this to 0 will disable the inactivity timeout.
- **Firmware Upgrade:** To update the unit's firmware, click the "Choose File" button to open the file selection window and then select the firmware update file (*.bin format) located on your local PC. After selecting the file, click the "Upgrade" button to begin the firmware update process. After the upgrade is complete, the unit will reboot automatically.

6.5 Telnet Control

Before attempting to use Telnet control, please ensure that both the unit and the PC are connected to the same active networks.

Start your preferred Telnet/Console client, or use the built in client provided by most modern computer operating systems. After starting the client, connect by using the current IP address of the unit and port 23 (if the communication port number used by the unit has not been changed previously). This will connect us to the unit we wish to control and commands may now be entered directly.

Note 1: If the IP address of the unit is changed then the IP address required for Telnet access will also change accordingly.

Note 2: The default IP address is 192.168.1.50 and the default communication port is 23.

6.6 Serial and Telnet Commands

COMMAND
Description and Parameters
help ← Show the full command list.
help N1 ← Show details about the specified command. N1 = {Command}
? ← Show the full command list.
? N1 ← Show details about the specified command. N1 = {Command}

COMMAND	
Description and Parameters	
get fw ver ↵	Show the unit's current firmware version.
get command ver ↵	Show the unit's current command version.
get mac addr ↵	Show the unit's MAC address.
get model name ↵	Show the unit's model name.
get model type ↵	Show the unit's product type index number.
set factory default ↵	Reset the unit to the factory defaults.
set factory ipconfig default ↵	Reset the unit's network settings to the factory defaults.
set factory out route default ↵	Reset the unit's routing to the factory defaults.
get user config ↵	List the unit's current configuration information.
get update filename ↵	Show the filename required when updating the unit's firmware.

COMMAND					
Description and Parameters					
set feedback broadcast N1 ←					
<p>Enable or disable the broadcast of console command feedback.</p> <p>Available values for N1:</p> <table> <tr> <td>ON</td> <td>[Enable]</td> </tr> <tr> <td>OFF</td> <td>[Disable]</td> </tr> </table>		ON	[Enable]	OFF	[Disable]
ON	[Enable]				
OFF	[Disable]				
get feedback broadcast ←					
<p>Show the current console command feedback broadcast state.</p>					
set system reboot ←					
<p>Reboot the unit.</p>					
set keylock N1 ←					
<p>Enable or disable the front panel key lock.</p> <p>Available values for N1:</p> <table> <tr> <td>ON</td> <td>[Front panel locked]</td> </tr> <tr> <td>OFF</td> <td>[Front panel unlocked]</td> </tr> </table>		ON	[Front panel locked]	OFF	[Front panel unlocked]
ON	[Front panel locked]				
OFF	[Front panel unlocked]				
get keylock ←					
<p>Show the current front panel lock state.</p>					
set ip mode N1 ←					
<p>Set the IP address assignment mode.</p> <p>Available values for N1:</p> <table> <tr> <td>STATIC</td> <td>[Static IP mode]</td> </tr> <tr> <td>DHCP</td> <td>[DHCP mode]</td> </tr> </table>		STATIC	[Static IP mode]	DHCP	[DHCP mode]
STATIC	[Static IP mode]				
DHCP	[DHCP mode]				
get ip mode ←					
<p>Show the current IP address assignment mode.</p>					
get ipconfig ←					
<p>Show the unit's current IP configuration information.</p>					

COMMAND	
Description and Parameters	
get ipaddr ↵	Show the unit's current IP address.
get netmask ↵	Show the unit's current netmask.
get gateway ↵	Show the unit's current gateway address.
set static ipaddr N1 ↵	Set the unit's static IP address. N1 = X.X.X.X [X = 0~255]
get static ipaddr ↵	Show the unit's current static IP address.
set static netmask N1 ↵	Set the unit's static netmask. N1 = X.X.X.X [X = 0~255]
get static netmask ↵	Show the unit's current static netmask.
set static gateway N1 ↵	Set the unit's static gateway address. N1 = X.X.X.X [X = 0~255]
get static gateway ↵	Show the unit's current static gateway address.
get telnet maximum user ↵	Show the maximum number of users allowed to connect simultaneously via Telnet.

COMMAND	
Description and Parameters	
set webgui username N1 ↵	
Set the WebGUI administrator login username.	
N1 = {Name}	[16 characters max]
get webgui username ↵	
Show the current WebGUI administrator login username.	
set webgui password N1 ↵	
Set the WebGUI administrator password.	
N1 = {Password}	[16 characters max]
get webgui password ↵	
Show the current WebGUI administrator password.	
set webgui login timeout N1 ↵	
Set the WebGUI inactivity timeout value.	
Available values for N1 :	
0	[No timeout]
1~240	[Timeout in minutes]
get webgui login timeout ↵	
Show the current WebGUI inactivity timeout value.	
set in N1 name N2 ↵	
Set the name of the specified input.	
Available values for N1 :	
1	[HDMI Input 1]
2	[HDMI input 2]
3	[DisplayPort input]
4	[VGA input]
N2 = {Name}	[16 characters max]

COMMAND	
Description and Parameters	
get in N1 name ↵	
Show the current name of the specified input.	
Available values for N1 :	
1	[HDMI Input 1]
2	[HDMI input 2]
3	[DisplayPort input]
4	[VGA input]
set out N1 name N2 ↵	
Set the name of the specified output.	
Available values for N1 :	
A	[HDMI output A]
B	[HDMI output B]
N2 = {Name}	[16 characters max]
get out N1 name ↵	
Show the name of the specified output.	
Available values for N1 :	
A	[HDMI output A]
B	[HDMI output B]
set out N1 route N2 ↵	
Route the specified input to the specified output.	
Available values for N1 :	
1	[HDMI Input 1]
2	[HDMI input 2]
3	[DisplayPort input]
4	[VGA input]
Available values for N2 :	
A	[HDMI output A]
B	[HDMI output B]

COMMAND									
Description and Parameters									
get out N1 route ↵	<p>Show the current input routed to the specified output.</p> <p>Available values for N1:</p> <table> <tr> <td>1</td> <td>[HDMI Input 1]</td> </tr> <tr> <td>2</td> <td>[HDMI input 2]</td> </tr> <tr> <td>3</td> <td>[DisplayPort input]</td> </tr> <tr> <td>4</td> <td>[VGA input]</td> </tr> </table>	1	[HDMI Input 1]	2	[HDMI input 2]	3	[DisplayPort input]	4	[VGA input]
1	[HDMI Input 1]								
2	[HDMI input 2]								
3	[DisplayPort input]								
4	[VGA input]								
get in port number ↵	<p>Show the total number of inputs on the unit.</p>								
get in name list ↵	<p>List the names of all inputs on the unit.</p>								
get out port number ↵	<p>Show the total number of outputs on the unit.</p>								
get out name list ↵	<p>List the names of all outputs on the unit.</p>								
set out auto mode N1 ↵	<p>Set the auto switching/scanning behavior of the unit.</p> <p>Available values for N1:</p> <table> <tr> <td>0</td> <td>[Off]</td> </tr> <tr> <td>1</td> <td>[Auto switch mode]</td> </tr> <tr> <td>2</td> <td>[Auto scan mode]</td> </tr> </table>	0	[Off]	1	[Auto switch mode]	2	[Auto scan mode]		
0	[Off]								
1	[Auto switch mode]								
2	[Auto scan mode]								
get out auto mode ↵	<p>Show the current auto switching/scanning mode of the unit.</p>								

COMMAND**Description and Parameters****get in N1 sync status**↵

Show the current sync state of the specified input.

Available values for **N1**:

1	[HDMI Input 1]
2	[HDMI input 2]
3	[DisplayPort input]
4	[VGA input]

Possible response values:

0	[No sync]
1	[Sync active]

get out N1 sync status↵

Show the current sync state of the specified output.

Available values for **N1**:

A	[HDMI output A]
B	[HDMI output B]

Possible response values:

0	[No sync]
1	[Sync active]

get out N1 h active↵

Show the horizontal active pixel value of the specified output's signal.

Available values for **N1**:

A	[HDMI output A]
B	[HDMI output B]

get out N1 v active↵

Show the vertical active pixel value of the specified output's signal.

Available values for **N1**:

A	[HDMI output A]
B	[HDMI output B]

COMMAND	
Description and Parameters	
get out N1 refresh rate ↵	
Show the refresh rate of the specified output's signal.	
Available values for N1 :	
A	[HDMI output A]
B	[HDMI output B]
get out N1 interlace ↵	
Show the interlace state of the specified output's signal.	
Available values for N1 :	
A	[HDMI output A]
B	[HDMI output B]
Possible response values:	
0	[Not interlaced]
1	[Interlaced]
get in N1 type ↵	
Show the port type of the specified input on the unit.	
Available values for N1 :	
1	[HDMI Input 1]
2	[HDMI input 2]
3	[DisplayPort input]
4	[VGA input]
get out N1 type ↵	
Show the port type of the specified output on the unit.	
Available values for N1 :	
A	[HDMI output A]
B	[HDMI output B]
get in type list ↵	
List the port type of all inputs on the unit.	

COMMAND	
Description and Parameters	
get out type list ↵	
	List the port type of all outputs on the unit.
set out route AN1,BN1 ↵	
	Set unique input routing for both outputs simultaneously.
	Available values for N1 :
1	[HDMI Input 1]
2	[HDMI input 2]
3	[DisplayPort input]
4	[VGA input]
set all out route N1 ↵	
	Route the specified input to all outputs.
	Available values for N1 :
1	[HDMI Input 1]
2	[HDMI input 2]
3	[DisplayPort input]
4	[VGA input]
get all out route ↵	
	Show the current routing for all outputs.
set current route to preset N1 ↵	
	Save all current routing assignments to the specified preset.
N1 = 1~4	[Preset number]
set route preset N1 ↵	
	Activate the routing assignments saved in the specified preset.
N1 = 1~4	[Preset number]

COMMAND
Description and Parameters
<p>get preset N1 list↵</p> <p>List the routing assignments stored in the specified preset.</p> <p>N1 = 1~4 [Preset number]</p>
<p>set route preset N1 name N2↵</p> <p>Set a name for the specified preset.</p> <p>N1 = 1~4 [Preset number]</p> <p>N2 = {Name} [32 characters max]</p>
<p>get route preset N1 name↵</p> <p>Show the current name of the specified preset.</p> <p>N1 = 1~4 [Preset number]</p>
<p>set audio out A mute N1↵</p> <p>Enable or disable muting all audio output.</p> <p>Available values for N1:</p> <p>ON [Mute]</p> <p>OFF [Unmute]</p>
<p>get audio out A mute↵</p> <p>Show the current mute state of all audio output.</p>
<p>set audio out A volume N1↵</p> <p>Set the master audio volume level.</p> <p>N1 = 0~100 [Volume level in dB steps]</p>
<p>get audio out A volume↵</p> <p>Show the current master audio volume level.</p>
<p>set audio out A volume up↵</p> <p>Increase the master audio volume level by 1 unit.</p>

COMMAND	
Description and Parameters	
set audio output A volume down ↵	Decrease the master audio volume level by 1 unit.
set audio in N1 pre-gain N2 ↵	Set the pre-gain volume level for the specified audio input type. Available values for N1 : 1 [Current video's audio] 2 [Front panel line in] N2 = 0~100 [Volume level in dB steps]
get audio in N1 pre-gain ↵	Show the current pre-gain volume level for the specified audio input. Available values for N1 : 1 [Current video's audio] 2 [Front panel line in]
get audio in type list ↵	List all available audio input sources.
get audio out type list ↵	List all available audio output destinations.
set audio mixer N1 ↵	Enable or disable the unit's audio mixer function. Available values for N1 : ON [Enable] OFF [Disable]
get audio mixer ↵	Show the current state of the unit's audio mixer.

COMMAND	
Description and Parameters	
set audio in 3 power mode N1 ←	
Set the microphone input's phantom power voltage level.	
Available values for N1 :	
0	[0V, no phantom power]
1	[48V, phantom power enabled]
get audio in 3 power mode ←	
Show the current phantom power voltage level of the microphone input.	
set audio mixer out A source N1	
When the mixer is enabled, sets the primary audio source to mix with the microphone input. When the mixer is disabled, sets the unit's audio output source.	
Available values for N1 :	
1	[Current video's audio]
2	[Front panel line in]
3	[Microphone input]
get audio mixer out A source ←	
Show the unit's currently selected primary audio source.	
set audio volume knob lock N1 ←	
Set the control location for the master volume and microphone gain controls.	
Available values for N1 :	
ON	[Front panel control]
OFF	[WebGUI control]
get audio volume knob lock ←	
Show the current control location for the master volume and microphone gain controls.	

COMMAND					
Description and Parameters					
set audio out A talkover N1 ←	<p>Enable or disable the mixer's audio talkover function.</p> <p>Available values for N1:</p> <table> <tr> <td>ON</td> <td>[Enable]</td> </tr> <tr> <td>OFF</td> <td>[Disable]</td> </tr> </table>	ON	[Enable]	OFF	[Disable]
ON	[Enable]				
OFF	[Disable]				
get audio out A talkover ←	<p>Show the mixer's current audio talkover state.</p>				
set audio out A talkover trigger time N1 ←	<p>Set the audio mixer's talkover trigger time value.</p> <p>N1 = 0~200 [Time in 1/10 seconds]</p>				
get audio out A talkover trigger time ←	<p>Show the current audio mixer's talkover trigger time value.</p>				
set audio out A talkover attack time N1 ←	<p>Set the audio mixer's talkover attack time value.</p> <p>N1 = 0~200 [Time in 1/10 seconds]</p>				
get audio out A talkover attack time ←	<p>Show the current audio mixer's talkover attack time value.</p>				
set audio out A talkover hold time N1 ←	<p>Set the audio mixer's talkover hold time value.</p> <p>N1 = 0~200 [Time in 1/10 seconds]</p>				
get audio out A talkover hold time ←	<p>Show the current audio mixer's talkover hold time value.</p>				

COMMAND
Description and Parameters
<p>set audio out A talkover release time N1 ↵</p> <p>Set the audio mixer's talkover release time value.</p> <p>N1 = 0~200 [Time in 1/10 seconds]</p>
<p>get audio out A talkover release time ↵</p> <p>Show the current audio mixer's talkover release time value.</p>
<p>set audio out A talkover depth N1 ↵</p> <p>Set the audio mixer's talkover depth value.</p> <p>N1 = 0~100 [Depth in percentage]</p>
<p>get audio out A talkover depth ↵</p> <p>Show the current audio mixer's talkover depth value.</p>
<p>set audio out A talkover threshold N1 ↵</p> <p>Set the audio mixer's talkover signal detection threshold value.</p> <p>N1 = -50~ -10 [Level in dB]</p>
<p>get audio out A talkover threshold ↵</p> <p>Show the audio mixer's current talkover signal detection threshold value.</p>

COMMAND**Description and Parameters****set in N1 edid N2**↵

Set the EDID to use on the specified input.

Available values for **N1**:

1	[HDMI Input 1]
2	[HDMI input 2]
3	[DisplayPort input]

Available values for **N2**:

1	[FHD 2CH]
2	[FHD MCH]
3	[UHD 2CH]
4	[UHD MCH]
5	[UHD+ 2CH]
6	[UHD+ MCH]
7	[User 1]
8	[User 2]
9	[User 3]
10	[User 4]
11	[Sink A]
12	[Sink B]

get in N1 edid↵

Show the EDID currently being used on the specified input.

Available values for **N1**:

1	[HDMI Input 1]
2	[HDMI input 2]
3	[DisplayPort input]

get in edid list↵

List all available EDID selections.

COMMAND	
Description and Parameters	
set edid N1 name N2↵	
Set the name for the specified EDID.	
Available values for N1 :	
7	[User 1]
8	[User 2]
9	[User 3]
10	[User 4]
N2 = {Name}	[32 characters max]
<i>Note: Only User EDIDs may be renamed.</i>	
get edid N1 name↵	
Show the name for the specified EDID.	
Available values for N1 :	
1	[FHD 2CH]
2	[FHD MCH]
3	[UHD 2CH]
4	[UHD MCH]
5	[UHD+ 2CH]
6	[UHD+ MCH]
7	[User 1]
8	[User 2]
9	[User 3]
10	[User 4]
11	[Sink A]
12	[Sink B]
set user N1 edid data N2↵	
Upload a new EDID (in hex format) for use as the specified User EDID.	
N1 = 1~4	[User EDID number]
N2 = {EDID data}	[Comma delimited hex pairs]

COMMAND	
Description and Parameters	
get user N1 edid data ↵	
Show the current contents of the specified User EDID as hex data.	
N1 = 1~4	[User EDID number]
get sink N1 edid data ↵	
Show the EDID from the display connected to the specified output as hex data.	
Available values for N1 :	
A	[HDMI output A]
B	[HDMI output B]
get in N1 edid data ↵	
Show the EDID currently used by the specified input as hex data.	
Available values for N1 :	
1	[HDMI Input 1]
2	[HDMI input 2]
3	[DisplayPort input]
4	[VGA input]
get all in edid list ↵	
List the EDIDs assigned to all inputs.	
get internal N1 edid data ↵	
Show the specified Internal EDID as hex data.	
Available values for N1 :	
1	[FHD 2CH]
2	[FHD MCH]
3	[UHD 2CH]
4	[UHD MCH]
5	[UHD+ 2CH]
6	[UHD+ MCH]

COMMAND																									
Description and Parameters																									
set all in edid N1 ↵	<p>Set the EDID to use when the “All” EDID mode is active.</p> <p>Available values for N1:</p> <table border="0"> <tr><td>1</td><td>[FHD 2CH]</td></tr> <tr><td>2</td><td>[FHD MCH]</td></tr> <tr><td>3</td><td>[UHD 2CH]</td></tr> <tr><td>4</td><td>[UHD MCH]</td></tr> <tr><td>5</td><td>[UHD+ 2CH]</td></tr> <tr><td>6</td><td>[UHD+ MCH]</td></tr> <tr><td>7</td><td>[User 1]</td></tr> <tr><td>8</td><td>[User 2]</td></tr> <tr><td>9</td><td>[User 3]</td></tr> <tr><td>10</td><td>[User 4]</td></tr> <tr><td>11</td><td>[Sink A]</td></tr> <tr><td>12</td><td>[Sink B]</td></tr> </table>	1	[FHD 2CH]	2	[FHD MCH]	3	[UHD 2CH]	4	[UHD MCH]	5	[UHD+ 2CH]	6	[UHD+ MCH]	7	[User 1]	8	[User 2]	9	[User 3]	10	[User 4]	11	[Sink A]	12	[Sink B]
1	[FHD 2CH]																								
2	[FHD MCH]																								
3	[UHD 2CH]																								
4	[UHD MCH]																								
5	[UHD+ 2CH]																								
6	[UHD+ MCH]																								
7	[User 1]																								
8	[User 2]																								
9	[User 3]																								
10	[User 4]																								
11	[Sink A]																								
12	[Sink B]																								
get all in edid ↵	<p>Show the current EDID used by the “All” EDID mode.</p>																								
get internal edid number ↵	<p>Show the total number of internal EDIDs the unit supports.</p>																								
get user edid number ↵	<p>Show the total number of user EDIDs the unit supports.</p>																								
get sink edid number ↵	<p>Show the total number of sink EDIDs the unit supports.</p>																								

COMMAND**Description and Parameters****set in N1 hdcp mode N2**↵

Set the HDCP behavior of the specified input.

Available values for **N1**:

1	[HDMI Input 1]
2	[HDMI input 2]
3	[DisplayPort input]

Available values for **N2**:

0	[HDCP support disabled]
1	[Refer to source]
2	[Refer to display]

get in N1 hdcp mode↵

Show the current HDCP behavior used by the specified input.

Available values for **N1**:

1	[HDMI Input 1]
2	[HDMI input 2]
3	[DisplayPort input]

get in N1 hdcp status↵

Show the current HDCP status of the specified input.

Available values for **N1**:

1	[HDMI Input 1]
2	[HDMI input 2]
3	[DisplayPort input]

Possible response values:

0	[No HDCP]
1	[HDCP 1.x]
2	[HDCP 2.2]

COMMAND

Description and Parameters

get out N1 hdcp status↵

Show the current HDCP status of the specified output.

Available values for **N1**:

A	[HDMI output A]
B	[HDMI output B]

Possible response values:

0	[No HDCP]
1	[HDCP 1.x active]
2	[HDCP 2.2 active]
3	[HDCP 1.x failed]
4	[HDCP 2.x2 failed]

get out N1 hdcp ability↵

Show the HDCP compliance level of the display device connected to the specified output.

Available values for **N1**:

A	[HDMI output A]
B	[HDMI output B]

Possible response values:

0	[No HDCP support]
1	[HDCP 1.x only]
2	[HDCP 2.2 only]
3	[HDCP 1.x+2.2]

COMMAND**Description and Parameters****get in N1 hdcp ability**↵

Show the HDCP compliance level of the source connected to the specified input.

Available values for **N1**:

1	[HDMI Input 1]
2	[HDMI input 2]
3	[DisplayPort input]

Possible response values:

0	[No HDCP support]
1	[HDCP 1.x only]
2	[HDCP 2.2 only]
3	[HDCP 1.x+2.2]

set out N1 cec data N2↵

Send a CEC command, as hex data, to the display connected to the specified output.

Available values for **N1**:

A	[HDMI output A]
B	[HDMI output B]

N2 = {CEC command} [Comma delimited hex pairs]

get out N1 cec capability↵

Show if the display connected to the specified output supports CEC.

Available values for **N1**:

A	[HDMI output A]
B	[HDMI output B]

Possible response values:

ON	[Supported]
OFF	[Unsupported]

Note: Commands will not be executed unless followed by a carriage return. Commands are not case-sensitive.

7. CONNECTION DIAGRAM

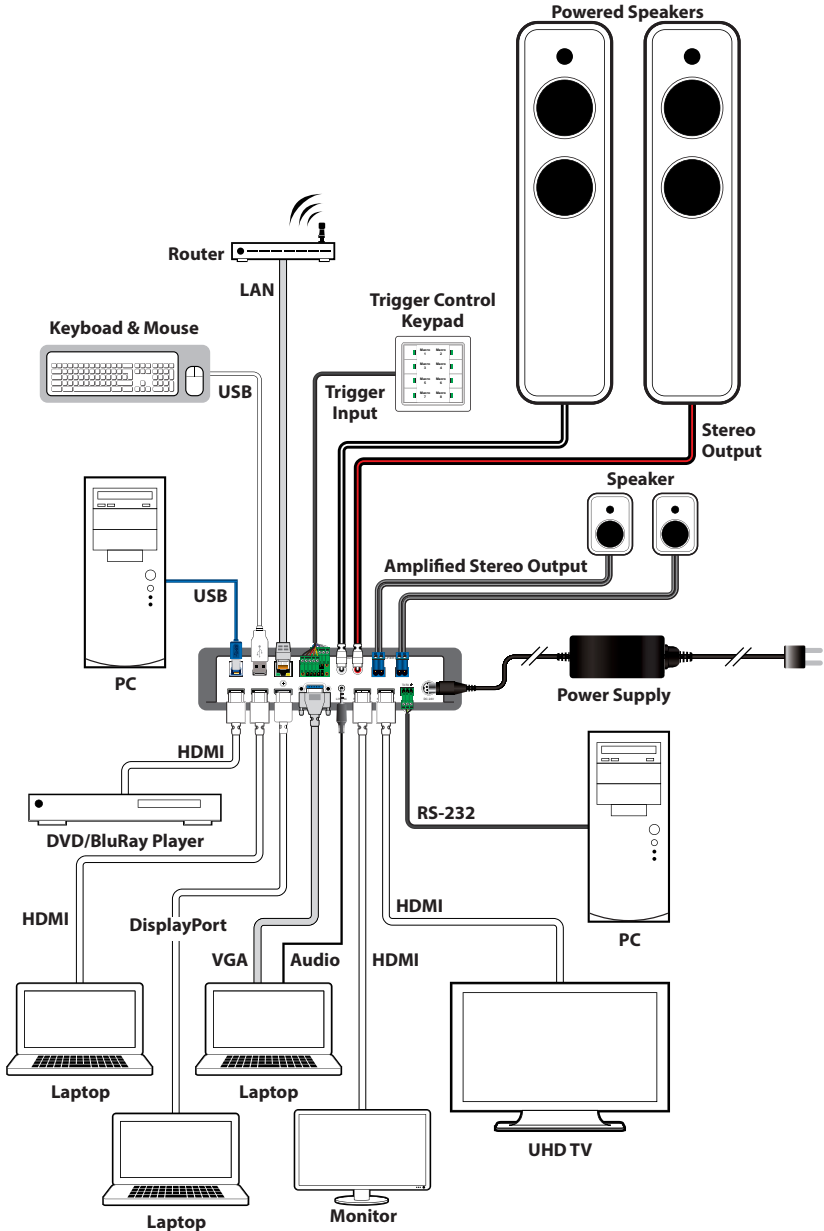

8. SPECIFICATIONS

8.1 Technical Specifications

HDMI Bandwidth	18Gbps
DisplayPort Bandwidth	21.6Gbps
VGA Bandwidth	165MHz
Input Ports	2×HDMI (Type-A) 1×DisplayPort 1×VGA (HD-15) 2×Analogue Stereo (3.5mm) 1×Microphone (6.35mm)
Output Ports	2×HDMI (Type-A) 1×Stereo Audio (2×RCA) 1×Stereo Audio (2×2-pin Terminal Block)
Pass-through Ports	2×USB 3.0 (Type-A) 1×USB 3.0 (Type-B)
Control Ports	1×RS-232 (3-pin Terminal Block) 1×Trigger (10-pin Terminal Block) 1×LAN (RJ-45)
Service/Pass-through Port	1×USB 3.0 (Type-A)
Baud Rate	19200
Power Supply	24V/3.75A DC (US/EU standards, CE/FCC/UL certified)
ESD Protection (HBM)	±8kV (Air Discharge) ±4kV (Contact Discharge)
Dimensions (W×H×D)	231.5mm×44mm×158mm [Case Only] 231.5mm×44mm×171mm [All Inclusive]
Weight	1200g
Chassis Material	Metal (Steel)
Chassis Colour	Black
Operating Temperature	0°C – 40°C/32°F – 104°F
Storage Temperature	-20°C – 60°C/-4°F – 140°F
Relative Humidity	20 – 90% RH (Non-condensing)
Power Consumption	43W

8.2 Video Specifications

Supported Resolutions (Hz)	Input			Output
	HDMI	DP	VGA	HDMI
720x400p@70/85	✓	✓	✓	✓
640x480p@60/72/75/85	✓	✓	✓	✓
720x480i@60	✓	✓	✓	✓
720x480p@60	✓	✓	✓	✓
720x576i@50	✓	✓	✓	✓
720x576p@50	✓	✓	✓	✓
800x600p@56/60/72/75/85	✓	✓	✓	✓
848x480p@60	✓	✓	✓	✓
1024x768p@60/70/75/85	✓	✓	✓	✓
1152x864p@75	✓	✓	✓	✓
1280x720p@50/60	✓	✓	✓	✓
1280x768p@60/75/85	✓	✓	✓	✓
1280x800p@60/75/85	✓	✓	✓	✓
1280x960p@60/85	✓	✓	✓	✓
1280x1024p@60/75/85	✓	✓	✓	✓
1360x768p@60	✓	✓	✓	✓
1366x768p@60	✓	✓	✓	✓
1400x1050p@60	✓	✓	✓	✓
1440x900p@60/75	✓	✓	✓	✓
1600x900p@60RB	✓	✓	x	✓
1600x1200p@60	✓	✓	✓	✓
1680x1050p@60	✓	✓	✓	✓
1920x1080i@50/60	✓	✓	✓	✓

Supported Resolutions (Hz)	Input			Output
	HDMI	DP	VGA	HDMI
1920×1080p@24/25/30	✓	✓	✓	✓
1920×1080p@50/60	✓	✓	✓	✓
1920×1200p@60RB	✓	✓	✗	✓
2560×1440p@60RB	✗	✗	✗	✗
2560×1600p@60RB	✗	✗	✗	✗
2048×1080p@24/25/30	✓	✓	✗	✓
2048×1080p@50/60	✓	✓	✗	✓
3840×2160p@24/25/30	✓	✓	✗	✓
3840×2160p@50/60 (4:2:0)	✓	✓	✗	✓
3840×2160p@24, HDR10	✓	✓	✗	✓
3840×2160p@50/60 (4:2:0),HDR10	✓	✓	✗	✓
3840×2160p@50/60	✓	✓	✗	✓
4096×2160p@24/25/30	✓	✓	✗	✓
4096×2160p@50/60 (4:2:0)	✓	✓	✗	✓
4096×2160p@24, HDR10	✓	✓	✗	✓
4096×2160p@50/60 (4:2:0),HDR10	✓	✓	✗	✓
4096×2160p@50/60	✓	✓	✗	✓

8.3 Audio Specifications

8.3.1 Digital Audio

HDMI Input / Output	
LPCM	
Max Channels	8 Channels
Sampling Rate (kHz)	32, 44.1, 48, 88.2, 96, 176.4, 192
Bitstream	
Supported Formats	Standard & High-Definition
DisplayPort Input	
LPCM	
Max Channels	8 Channels
Sampling Rate (kHz)	32, 44.1, 48, 88.2, 96, 176.4, 192
Bitstream	
Supported Formats	Standard & High-Definition

8.3.2 Analogue Audio

Analogue Input (Stereo 3.5mm)	
Max Audio Level	2Vrms
Impedance	28k Ω
Type	Unbalanced
Analogue Input (Microphone 6.35mm)	
Max Audio Level	2Vrms
Impedance	28k Ω
Type	Balanced
Analogue Output (RCA Pair)	
Max Audio Level	2Vrms
THD+N	< -92dB@0dBFS 1kHz (A-wt)
SNR	> 106dB@0dBFS
Frequency Response	< \pm 3dB@20Hz~20kHz
Crosstalk	< -84dB@10kHz
Impedance	1k Ω
Type	Unbalanced
Analogue Output (2-pin Terminal Block Pair)	
Max Audio Power	20W+20W
THD+N	< -66dB@0dBFS 1kHz (A-wt)
SNR	> 100dB@0dBFS
Frequency Response	< \pm 3dB@20Hz~20kHz
Crosstalk	< -80dB@10kHz
Impedance	4-16 Ω
Type	Balanced

8.4 Cable Specifications

Cable Length	1080p		4K30	4K60
	8-bit	12-bit	(4:4:4) 8-bit	(4:4:4) 8-bit
High Speed HDMI Cable				
HDMI Input	10m		5m	3m
HDMI Output	10m		5m	3m
DisplayPort Cable				
DisplayPort Input	10m		2m	
VGA Cable				
VGA Input	2m		x	

Bandwidth Category Examples:

1080p (FHD Video)

- Up to 1080p@60Hz, 12-bit colour
- Data rates lower than 5.3Gbps or below 225MHz TMDS clock

4K30 (4K UHD Video)

- 4K@24/25/30Hz & 4K@50/60Hz (4:2:0), 8-bit colour
- Data rates higher than 5.3Gbps or above 225MHz TMDS clock but below 10.2Gbps

4K60 (4K UHD⁺ Video)

- 4K@50/60Hz (4:4:4, 8-bit)
- 4K@50/60Hz (4:2:0, 10-bit HDR)
- Data rates higher than 10.2Gbps

9. ACRONYMS

ACRONYM	COMPLETE TERM
ADC	Analogue-to-Digital Converter
ASCII	American Standard Code for Information Interchange
Cat.5e	Enhanced Category 5 cable
Cat.6	Category 6 cable
Cat.6A	Augmented Category 6 cable
Cat.7	Category 7 cable
CEC	Consumer Electronics Control
CLI	Command-Line Interface
DAC	Digital-to-Analogue Converter
dB	Decibel
DHCP	Dynamic Host Configuration Protocol
DP	DisplayPort
DVI	Digital Visual Interface
EDID	Extended Display Identification Data
Gbps	Gigabits per second
GUI	Graphical User Interface
HDCP	High-bandwidth Digital Content Protection
HDMI	High-Definition Multimedia Interface
HDR	High Dynamic Range
IP	Internet Protocol
kHz	Kilohertz
KVM	Keyboard/Video/Mouse
LAN	Local Area Network
LED	Light-Emitting Diode

ACRONYM	COMPLETE TERM
LPCM	Linear Pulse-Code Modulation
MAC	Media Access Control
MHz	Megahertz
SNR	Signal-to-Noise Ratio
TCP	Transmission Control Protocol
THD+N	Total Harmonic Distortion plus Noise
4K UHD	4K Ultra-High-Definition (10.2Gbps max)
4K UHD⁺	4K Ultra-High-Definition (18Gbps max)
UHDTV	Ultra-High-Definition Television
USB	Universal Serial Bus
VGA	Video Graphics Array
WUXGA (RB)	Widescreen Ultra Extended Graphics Array (Reduced Blanking)
XGA	Extended Graphics Array
Ω	Ohm



CYP (UK) Ltd., Unit 7, Shepperton Business Park, Govett Avenue, Shepperton, Middlesex, TW17
8BA

Tel: +44 (0) 20 3137 9180 | Fax: +44 (0) 20 3137 6279

Email: sales@cypeurope.com

www.cypeurope.com

v1.00