

1008111030

## TCIS-3

IP and SIP Intercom



- ✓ General-purpose intercom station
- ✓ Black thermoplastic front plate with one call-button
- ✓ Superior audio quality with advanced audio processing
- ✓ High sound pressure levels with automatic volume adjustment
- ✓ Dirt, dust and water resistant
- ✓ High impact protection rating
- ✓ ONVIF Compatible
- ✓ Supports wide set of IP and networking standards



Door Intercom



SIP



Avaya Certified



CISCO Certified

**NEC** NEC Certified

UL Certified Intercom



Turbine

**IC-EDGE** IC-Edge

ICX-AlphaCom



IP66



IK08



Automatic Volume



HD Voice



Automatic Gain Control



Active Noise Cancelling



Voice Activity Detection

## Description

This Intercom station utilizes the latest technology to create unparalleled audio quality. Some of the many features include: HD voice quality, Open Duplex, Active Noise Cancellation, MEMS microphone, a 10W Class D amplifier and our unique speaker grille design. These features, in conjunction with our 70+ years of experience with acoustic technology are only a few of the many factors that contribute to our superior audio quality.

See also: [additional documentation on wiki.zenitel.com](http://wiki.zenitel.com)

# Technical Dimensions

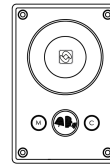
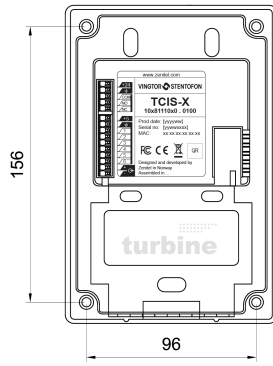
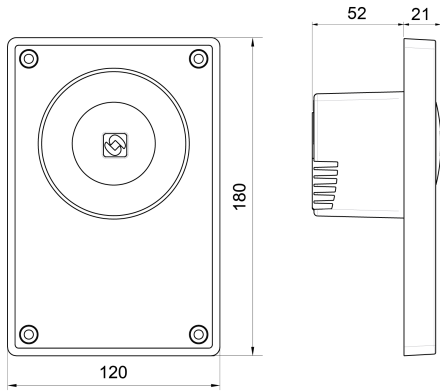

TCIS-1

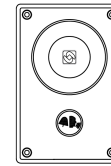

TCIS-2

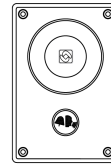

TCIS-3

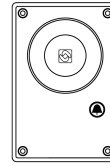

TCIS-4

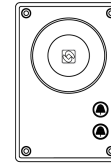

TCIS-5/TCIS-C1

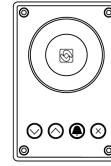

TCIS-6

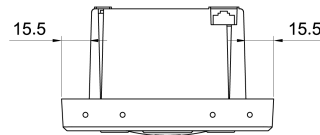
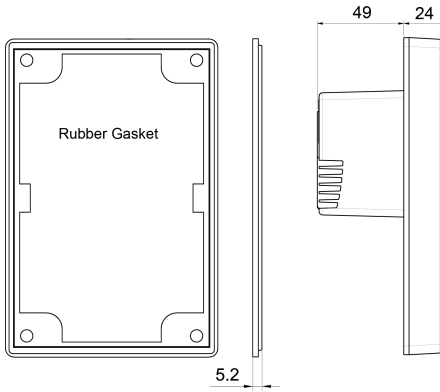

All dimensions in mm

# Specifications

## AUDIO

Internal speaker amplifier	10 W class D
Internal speaker	10 W
Microphone technology	Digital MEMS, omnidirectional microphone
Audio technology	Modes: Full open duplex, switched open duplex
	Adaptive jitter buffer
	Custom Ringing Tone
	Audio Mixing – Conversation and Group Call
	Automatic gain control (microphone)
	Sound Level Detection / scream alarm (in AlphaCom mode)
Codecs	G.711, G.722, G.729
Frequency range, G.722 Codec	200 Hz – 7000 Hz
SPL peak power at 1m in open duplex	95 dB
SPL peak power at 1m in half duplex	105 dB
SPL peak power at 1m in program distribution and announcements	105 dB
Noise cancelling	Yes
Automatic Volume Control (AVC)	Yes
Acoustic Echo Cancellation (AEC)	Yes

## HARDWARE

Ethernet connector	1 x RJ 45
All other connectors	Tool less, spring loaded, vibration proof terminals
General inputs and outputs	6 (configurable)
Outputs	12mA as LED drivers
Change-over relay (NO+NC+COM)	SELV
Power options	PoE or 24 VDC (16 – 48 V)
PoE (Power over Ethernet)	IEEE 802.3af standard
Power consumption	Idle 1.8W, max 12W (depending on volume)
Audio line out / induction loop signal	0 dBV
Button backlight	LED
Call indication	Icons/colors for hearing impaired

## CONSTRUCTION

Dimensions (HxWxD)	180 x 120 x 73 mm / 7.1" x 4.7" x 2.9"
Dimensions after flush mount	180 x 120 x 24 mm / 7.1" x 4.7" x 0.9"
Dimensions with on wall box	180 x 120 x 86 mm / 7.1" x 4.7" x 3.4"
Weight	0.8 kg / 1.8 lbs
Faceplate material	3 mm / 0.12" PMMA, colour printed on back side
Base / frame material	3 mm / 0.12" Aluminum alloy - A413.0, AISi12Fe, painted
Electronics cover material	Polycarbonate (translucent)
Gasket material	Silicone rubber
Fastening bracket material	SECC Steel
Button material	3 mm / 0.12" Polycarbonate (transparent)
Button travel length	1.25 mm
Button activation force	350 gf
Button push-cycles before failure	300 000
Loudspeaker poke protection, large diameter object	3D cast aluminum speaker grille
Loudspeaker poke protection, small diameter objects	Stainless steel mesh, acoustically transparent

## NETWORKING AND PROTOCOLS

---

Protocols	IPv4 (with DiffServ), SIP, TCP, UDP, HTTPS, TFTP, RTP, SRTP, DHCP, SNMP, ONVIF, CCoIP®, NTP
LAN protocols	Power over Ethernet (IEEE 802.3 a-f), Network Access Control (IEEE 802.1x)
Management and operation	HTTP/HTTPS (Web administration and configuration) DHCP and static IP. Remote automatic software upgrade. Centralized monitoring.
Advanced supervision functions	E.g. network test, tone test, status reports, uptime, button status.
SIP support	RFC 3261 (SIP base standard) RFC 3515 (SIP refer) RFC 2976 (SIP info), SIP using TLS, RFC 5630 SIPS URI scheme
DTMF support	RFC 2833, 2976 (SIP info)

---

## ENVIRONMENT AND COMPLIANCES

IP rating	IP-66 (applies when mounted in TA-1 back box)
IK rating	IK 08
Operating temperature range	-40° to 70° C
Storage temperature range	-40° to 70° C
Relative humidity	< 95% not condensing
Corrosion	Salty mist, tested according to EN60945
Vibration	Tested according to EN60945
UV-resistant	YES
EMC	CE and FCC Part 15 EN 50121-3-2 Railway application EN 50121-4 Railway application UN Regulation 10, revision 4 + Corr.1 + Amend.1
Compliances	IEC/EN 60945 Marine Equipment IEC/EN61000-6-1 and IEC/EN61000-6-3 (light industry) IEC/EN 50155 Railway Application * IEC/EN 50486 Equipment for use in audio video door-entry systems * With additional conformal coating Requires use of EN 50155 approved PoE switch
Certifications	UL 60950-1, cUL 60950-1, CB to IEC 60950-1

## OTHER SPECIFICATIONS

IP adress information	Speaks IP address after system boot
Country of manufacture	Poland

## Accessories



TA-1

Turbine Compact Onwall Back Box



TA-2

US 2-Gang 3 1/2" Deep Backbox



TA-5

Bracket for US 2 GANG Double Depth Back Box



Turbine Adapter Plate



TA-18

Turbine Compact Flush-Mount Back Box



TA-14

Microphone windshield for TCIS / TCIV



Touchless Sensor