

# Operation Manual

## Multi Source Player **CD-6208**



\* Rack mount products in the Western Hemisphere(North America, South America, and the Caribbean) do not have handles installed due to customer preference.

**interM**

# Welcome

## A personal welcome to you from the management and employees of Inter-M

All of the co-workers here at Inter-M are dedicated to providing excellent products with inherently good value, and we are delighted you have purchased one of our products.

We sincerely trust this product will provide years of satisfactory service, but if anything is not to your complete satisfaction, we will endeavor to make things right.

Welcome to Inter-M, and thank you for becoming part of our worldwide extended family!



This symbol is intended to alert the user to the presence of uninsulated “dangerous voltage” within the product’s enclosure that may be of sufficient magnitude to constitute a risk of electric shock to persons.



This symbol is intended to alert the user to the presence of important operation and maintenance (servicing) instructions in the literature accompanying the appliance.

Caution: To prevent electric shock do not use this (polarized) plug with an extension cord, receptacle or other outlet unless the blades can be fully inserted to prevent blade exposure.

Attentions: Pour prévenir les chocs électriques ne pas utiliser cette fiche polarisée avec un prolongateur, une prise de courant ou une autre sortie de courant, sauf si les lames peuvent être insérées à fond sans en laisser aucune partie à découvert.

## WARNING

To prevent fire or shock hazard, do not expose the unit to rain or moisture.

\*WARNING FOR YOUR PROTECTION PLEASE READ THE FOLLOWING-WATER AND MOISTURE: Unit should not be used near water(e.g. near a bathtub, washbowl, kitchen sink, laundry tub, in a wet basement, or near a swimming pool, etc). Care should be taken so than objects do not fall and liquids are not spilled into the enclosure through openings.

\*Do not install this equipment in a confined space such as a book case or similar unit.

\*This apparatus shall not be exposed to dripping or splashing and no objects filled with liquids, such vases, shall be placed on the apparatus.

\*This apparatus shall be connected to a mains socket outlet with a protective earthing connection.

\*It has heed to be easy to disconnect the device. To disconnect the device from power, separate AC input cable from inlet or unplug the AC Cord.

\*The socket-outlet shall be installed near the equipment and shall be easily accessible.

## CAUTION

\*These servicing instructions are for use by qualified service personnel only. To reduce the risk of electric shock, do not perform any servicing other than that contained in the operating instructions unless you are qualified to do so.

## NOTE

\*This equipment has been tested and found to comply with the limits for a Class A digital device, pursuant to Part 15 of the FCC Rules. These limits are designed to provide reasonable protection against harmful interference when the equipment is operated in a commercial environment. This equipment generates, uses, and can radiate radio frequency energy and, if not installed and used in accordance with the instruction manual, may cause harmful interference to radio communications. Operation of this equipment in a residential area is likely to cause harmful interference in which case the user will be required to correct the interference at his own expense.

# Contents

<b>Unpacking</b> .....	2
<b>Installation</b>	
Environment.....	2
Important Safety Instructions.....	2
<b>Features</b> .....	3
<b>Additional Descriptions</b> .....	4
<b>Method to treat Compact Disc (CD)</b> .....	5
<b>Front Panel</b> .....	6
<b>Rear Panel</b> .....	9
<b>Operating Method</b> .....	10
1. PLAYBACK.....	10
2. REPEAT .....	13
3. INSTANT PLAY .....	13
4. AUTO PLAY.....	14
5. RECORDING .....	15
6. DELETE .....	16
7. CUE .....	18
8. PITCH.....	18
9. EJECT .....	18
10. DISPLAY MODE .....	19
11. CAUTION.....	19
<b>Block Diagram</b> .....	20
<b>Specifications</b> .....	21
<b>Service</b>	
Procedures.....	23
Schematic .....	23
Parts List .....	23
<b>Variations and Options</b> .....	23
<b>Warranty</b> .....	23

## Unpacking

Please take a few minutes to read this manual to familiarize yourself with important information regarding installation, product features, and operation.

As with most electronic devices, ORIGINAL PACKAGING (OR EQUAL) IS REQUIRED in the unlikely event that the product needs to be returned for servicing.

## Installation

### Environment

Never place this product in an environment which could alter its performance or reduce its service life. Such environments usually include high levels of heat, dust, moisture, and vibration.

## IMPORTANT SAFETY INSTRUCTIONS

1. Read these instructions.
2. Keep these instructions.
3. Heed all warnings.
4. Follow all instructions.
5. Do not use this apparatus near water.
6. Clean only with dry cloth.
7. Do not block any ventilation openings. Install in accordance with the manufacturer's instructions.
8. Do not install near any heat sources such as radiators, heat registers, stoves, or other apparatus (including amplifiers) that produce heat.
9. Do not defeat the safety purpose of the polarized or grounding-type plug. A polarized plug has two blades with one wider than the other. A grounding type plug has two blades and a third grounding prong. The wide blade or the third prong are provided for your safety. If the provided plug does not fit into your outlet, consult an electrician for replacement of the obsolete outlet.
10. Protect the power cord from being walked on or pinched particularly at plugs, convenience receptacles, and the point where they exit from the apparatus.
11. Only use attachments/accessories specified by the manufacturer.
12. Use only with the cart, stand, tripod, bracket, or table specified by the manufacturer, or sold with the apparatus. When a cart is used, use caution when moving the cart/apparatus combination to avoid injury from tip-over.
13. Unplug this apparatus during lightning storms or when unused for long periods of time.
14. Refer all servicing to qualified service personnel. Servicing is required when the apparatus has been damaged in any way, such as power-supply cord or plug is damaged, liquid has been spilled or objects have fallen into the apparatus, the apparatus has been exposed to rain or moisture, does not operate normally, or has been dropped.



## Features

### - HIGH PERFORMANCE DAC

One of the best-sounding D/A chip, PCM1796 of Burr Brown is used.

### - MEMORY FUNCTION

Reaping a CD with mp3 format into the built-in memory or copying USB files into the built-in memory. Using memory function instead of CD playback can greatly save the lifetime of the CD mechanism.

### - USB

MP3 files in a USB can be played directly.

### - INSTANT PLAY FUNCTION

Can be set 10 tracks in 6 memory discs into 10 instant play buttons and it can play the track directly using 10 instant play buttons.

### - MP3/WMA

Can be playback CD-DA, MP3 or WMA.

### - AUTO PLAY

Automatically playback the preset source when the unit is turned on.

### - PITCH CONTROL

Controls play speed rapidly or slowly as your preference.

### - DIGITAL AUDIO OUTPUTS

Optical and coaxial output provides the S/PDIF digital audio.

### - ANTI SHOCK FUNCTION

Strong anti-shock function

### - RS-232C

Can be controlled by a remote controller such as AMX or CRESTRON system.

### \* Internal Memory

Adopting a built-in memory (8G Byte) enables to save files up to 300 files per each memory disc. The built-in memory consists of 6 memory discs.

## Additional Descriptions

### - MP3 (MPEG AUDIO LAYER-3)

MP3 is one of music file formats that can contain music with stereo sound quality as good as audio which is a type of MPEG as audio, video compression standards. Compression rate is 1Mb by 1 and thus about 3~ 5 minutes are sufficient if recording songs of 3~ 5 min or so. Differently from audio a music file made of MP3 can contain over 130 songs for popular songs or folk songs and playing also about 10 hours. MP3 clears frequency range for a human being not to discernable and advantage to compact it to 1/12 or so while maintaining music as sound quality equivalent to CD level.

Example, deriving a song in a music CD while maintaining music as sound quality equivalent to CD becomes capacity of 50MB or so but if compressing and converting it to a MP3, size of the MP3 reduces to 4~5MB.

### - WMA (WINDOWS MEDIA AUDIO)

WMA is a multimedia compression method developed by Microsoft Corporation and is technology compress only music from 'Window Media Technologies', and provides same sound quality as format MP3 up to 128Kbps, which has lower 64Kbps format than MP3.

In other words, it has a file size of the half of the MP3 and provides same sound quality as MP3.

### - DIGITAL OUTPUT AND STANDARDS

Audio signal of a CD records digitalized signal. Usually digital audio signals are converted to analog signals with a Digital Analog Converter (DAC) within a player. On the other hand, digital signal is replaced with optical signal by coaxial cables, semiconductor laser or light emitting diode (LED), etc and can be connected to the other devices with optical fiber cables. The unit receiving optical signal converts optical signals to electrical signals again for various processes. Transmitting digital data as they are is less affected by electrical noise than electrical signals, and thus less data error occurs.

The digital interface used in this product is a form of S/PDIF (Sony/Philips Digital Interface) and complies with standards called as IEC958.

### - RS-232C SERIAL INTERFACE

AMX or CRESTRON remote control system can be used with this RS-232C terminal.

The maximum cable length should be below 15m.

#### 1. RS-232C Terminal

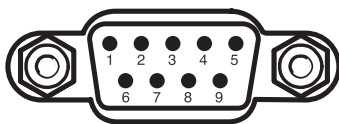

Pin	1	2	3	4	5	6-9
Purpose	X	Receive	Transmit	X	Ground	X

#### 2. Remote control function

Play/Pause, Stop, Skip down/up, Search Down/up, etc can be controlled by a remote controller.

#### 3. Downloading of the control protocol

You can download the protocol at the home page ([www.inter-m.com](http://www.inter-m.com)).

## Method to treat Compact Disc (CD)

The CD-6208 is designed for the playback of CD-DA, MP3, or WMA.  
Please use a CD with following mark:



- Make the label side upward when inserting a CD in the disc slot.
- Open a CD case with holding the right ending part of a case with the left hand and hold the both sides with the right hand from below.
- Take off the CD with lightly holding both sides with the right hand while pressing the center of the case with index finger.
- Lightly wipe out the CD with a soft cloth if fingerprint or dirt is stained on the signal side (opposite the label side). Wiping out dirt or fingerprint gently with a smooth cloth. Keep disc clean and store it in its case when not being played.
- Do not use any record spray, anti-static solutions, benzene and paint thinner or other chemical agents to clean a CD. The surface of a CD may be damaged by these chemical agents.
- Please keep the disc in its case after use to avoid serious scratches that could cause the laser pickup to skip.
- Keep discs away from direct sunlight, and places of high heat and humidity. It may cause deformation.
- Do not paste papers, etc to the label side. Do not write on the disc with a ballpoint pen.
- Only use circular compact discs, Avoid using non-circular promotional, etc. discs.
- The CD-6208 cannot play unfinalized CD-R/RW discs.

## Front Panel

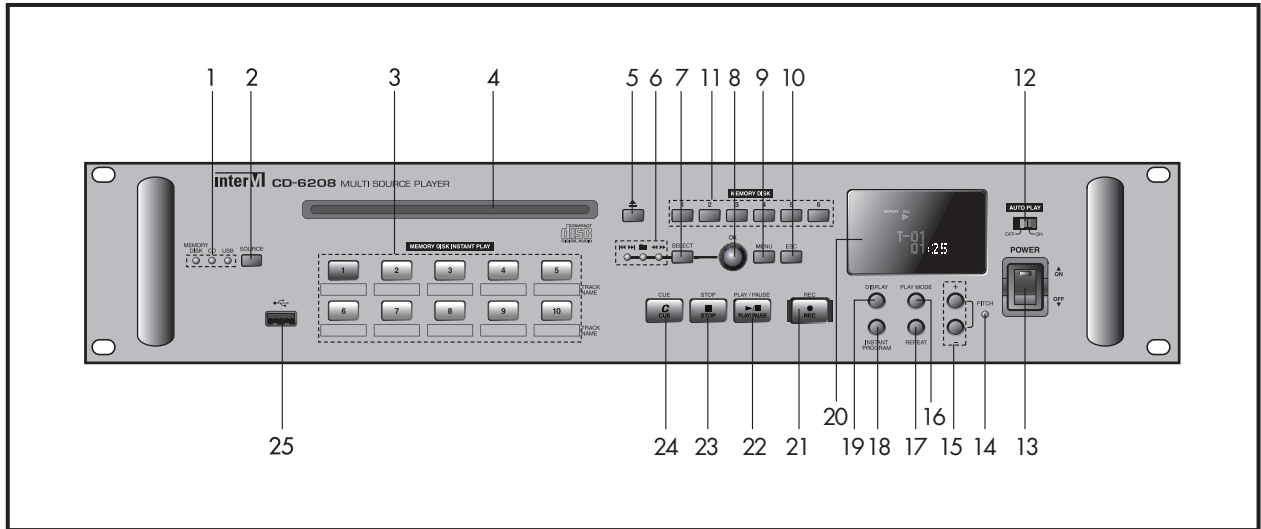

### 1. SOURCE SELECT LED

Indicating LED for the selected source.

↳ CD → USB → Memory Disc

### 2. SOURCE SELECT BUTTON

Push this button to select the source.

↳ CD → USB → Memory Disc

### 3. MEMORY DISK INSTANT PLAY BUTTON

Use this button to memory 10 tracks in 6 memory discs and to play the preset track directly.

### 4. DISC SLOT

Insert a CD into the slot, label side upwards.

The unit will pull the disc when the CD is partially inserted.

※ **DO NOT INSERT a CD of 8 cm size into the slot.**

### 5. EJECT BUTTON

Ejects a disc.

### 6. SELECT LED

The LEDs indicates the Skip (⏮ ⏭), Folder (■) or Search (⏪ ⏩) mode.

### 7. SELECT BUTTON

Use this button to select the Skip (⏮ ⏭), Folder (■) or Search (⏪ ⏩) mode.

After select the mode, skip, folder or search function can be performed using the ENCODER switch.

- Skip (⏮ ⏭) : skips a track or a folder.

- Folder (■) : skips a folder.



- Search (◀▶) : turning the ENCODER switch to the clockwise, then it searches forward continuously. Turning the encoder switch to the counter clockwise, then it searches backward continuously. Press the OK button to stop searching and playback the track.

## 8. ENCODER SWITCH / OK BUTTON

Rotates this ENCODER switch to perform skip, folder change or search function after select the Skip (◀▶), Folder (■) or Search (◀▶) mode. In menu mode, turning this ENCODER switch can changes the menu and pushing this button can change the setting.

## 9. MENU BUTTON

Use this button to select the menu, DELETE MDISK, AUTO PLAY, DELETE INSTANT or PITCH setting.  
 ※ **MENU button can be used when the unit is in stop mode.**

## 10. ESC BUTTON

Use this button to move back the menu in menu mode.

## 11. MEMORY DISC SELECT BUTTON

Use this button to select the one of the 6 memory discs.

## 12. AUTO PLAY SWITCH

Use this switch to set the auto play function.

By setting this switch on, the preset source of a memory disc, CD or USB is automatically played when the unit is turned on.

Playback starts from the first track of the preset source.

## 13. POWER SWITCH

Use this switch to turn the power on or off.

## 14. PITCH LED

This LED indicates that the pitch function is on.

## 15. PITCH CONTROL BUTTON (+ /-)

Push this button to control the pitch function.

## 16. PLAY MODE

Use this button to stop the playback after 1 track is played.

When the PLAY mode button is pressed during the playback, playback is stopped after the playback of the track is end.

## 17. REPEAT BUTTON

Use this button to select repeat mode, REPEAT 1, REPEAT GROUP, or REPEAT ALL.

## 18. INSTANT PROGRAM BUTTON

Use this button to memory 10 tracks in 6 memory discs into 10 instant play buttons.

※ **In CD or USB function, the Instant Program button or the Instant Play function can not be used.**

**19. DISPLAY BUTTON**

Use this button to select time mode, playback time or remaining time.

**20. DISPLAY WINDOW**

The display shows the current status of the unit or the current menu setting.

**21. RECORD BUTTON**

Use this button to reap a CD into the internal memory with mp3 format or copy the files of USB to the internal memory.

※ The memory disc (1~5) has 1 Gbyte memory and the memory disc (6) has 3 Gbyte memory.

**22. PLAY / PAUSE BUTTON**

Use this button to play or pause.

**23. STOP BUTTON**

Use this button to stop playback, reaping, or copying files from USB.

Also this button can exit all the menu mode.

**24. CUE BUTTON**

When the CUE is on and a track is selected, the point where sound begins on that track is located to and the unit enters into pause mode.

When the play button is pressed, playback begins at exactly that point.

**25. USB**

Use this terminal to mount USB memory.

MP3 or WMA files in the USB memory can be played or can be copied to the internal memory.

The unit supports USB 1.1.

## Rear Panel

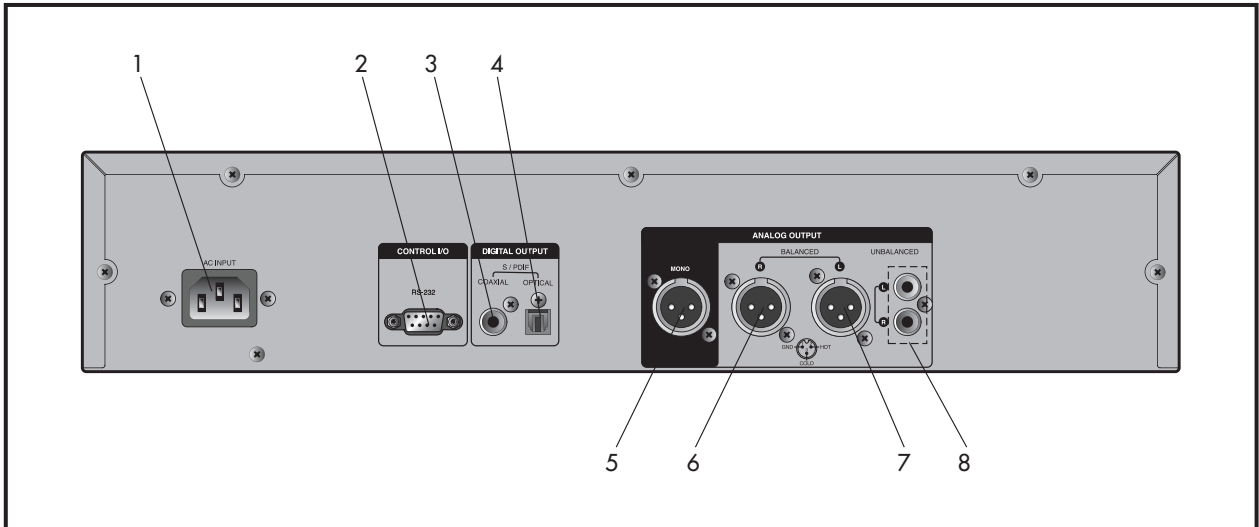

### 1. AC INLET

Connect the power cable supplied with the CD-6208.

### 2. RS-232C TERMINAL

This terminal allows control by a remote controller such as AMX /CRESTRON etc.  
The control protocol can be downloaded from the home page. ([www.inter-m.com](http://www.inter-m.com))

### 3. COAXIAL OUTPUT

This terminal provides the digital audio signal in S/PDIF format.

### 4. OPTICAL OUTPUT

This terminal provides the digital audio signal in S/PDIF format.

### 5. ANALOG MONO OUTPUT

MONO output terminal provides the mixed signal of L and R channel outputs.  
The maximum output level is +8dBu.

### 6. ANALOG R CHANNEL OUTPUT (XLR)

This terminal provides R channel signal output. The maximum output level is +8dBu.

### 7. ANALOG L CHANNEL OUTPUT (XLR)

This terminal provides L channel signal output. The maximum output level is +8dBu.

### 8. ANALOG L/R OUTPUT (RCA)

These terminals provide L and R channel signal output. The maximum output level is +8dBu.

# Operating Method

## 1. PLAYBACK

- (1) Push the power switch to turn the power on.  
The display will indicate NO DISC.
  - (2) Insert a disc into the slot, label side upwards.  
DO not forces the disc into the slot, the unit will pulls the disc when the CD is partially inserted.
- ※ **DO NOT INSERT a CD of 8 cm size into the slot.**

### 1) CD function

- Playback disc is a ordinary audio CD, CD-R or CD-RW disc recorded in CD-DA format and properly finalized.

- (1) Select CD mode by pressing the SOURCE button when the source is not in CD mode



The default source is CD.

- Up to 499 music can be displayed and can be playback.
- (2) After a disc is inserted, the display will indicate the information as below.
    - CD-DA : displays total number of tracks and total playback time.

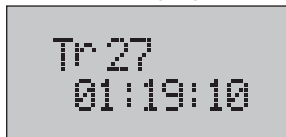

→ Track : 27 tracks  
Total Playback Time: 1hour 19min. 10sec.

- CD-MP3 : displays total number of folders and total number of files.

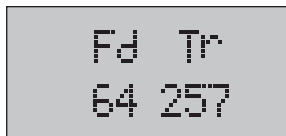

→ Folder : 64 folders  
Track : 257 tracks.

- (3) Select a track or a file to playback using the select button and the encoder switch.

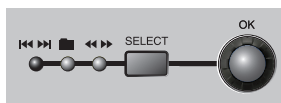

- CD-DA: select ◀▶▶ using the SELECT button and select the track to playback by turning the ENCODER switch.
- MP3:
  - select ■ using the SELECT button and select the folder by turning the ENCODER switch.
  - select ◀▶▶ using the SELECT button and select the track to playback by turning the ENCODER switch.

- (4) Press the  button to play.

To skip the track during playback, select ◀▶▶ using the SELECT button and select the track to playback by turning the ENCODER switch.

(5) Press the  button again to pause.

Press the  button to stop.

※ **Note:**

1. A disc which surface status is not good or a disc which format is not compatible cannot be played and stopped.
2. When a disc format is not compatible, the window displays "READING ERROR".
3. When a disc is inserted upside down, then the window displays "READING ERROR".
4. Only a disc with the size of 12cm is available and a disc of 8cm must not be used.

Check the disc status and format because these are not failure of this unit.

## 2) USB function

(1) Insert a USB memory to the USB terminal.



(2) Press the SOURCE select button to select the USB mode.



(3) Total numbers of the folders and total numbers of files to play are displayed.

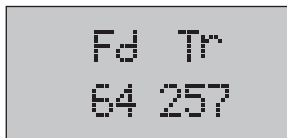

→ Folder : 64 folders  
Track : 257 tracks

If no files to play, then "NO FILE" is displayed.

if a USB memory is not inserted "NO USB" is displayed.

(4) Select a track to playback using the SELECT button and the ENCODER switch.

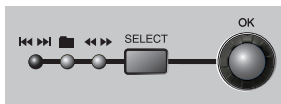

- select  using the SELECT button and select a folder by turning the ENCODER switch.

 can be selected only when the USB has folder.

- select  using the SELECT button and select a track to playback by turning the the ENCODER switch.

(5) Press the  button to play.

To skip the track during playback, select  using the SELECT button and select the track to playback by turning the ENCODER switch.

(6) Press the  button again to pause.

Press the  button to stop.

※ **Note:**

When the track which status is not good or which format is not compatible, the window displays "PLAY ERROR". The error track is skipped and playback the next track.

### 3) Memory Disc function

The CD-6208 has internal memory of 8GByte.

The memory discs from 1 to 6 are virtual disc of the internal memory.

The reaping files from CD-DA are saved in the internal memory and the files copied from a USB are saved in the internal memory.

※ Using memory function instead of CD playback can greatly save the lifetime of the CD mechanism.

(1) Press the SELECT button to select the memory disc mode.

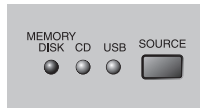

(2) Total numbers of files to play are displayed



→ Track : 257 tracks

If no files to play, "No File" is displayed on the window.

(3) Select the memory disc

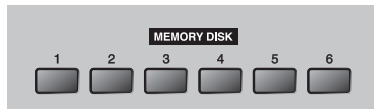

Selected memory disc number is blink on the window

※ If no files in the memory disc, then the memory disc can not be selected.

Only the memory disc which has music files is displayed the memory disc number on the window.

(4) Select the track to playback using the SELECT button and the ENCODER switch.

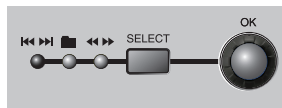

select **⏮ ⏭** using the SELECT button and select the track to playback by turning the ENCODER switch.

(5) Press the  button to play.

To skip the track during playback, select **⏮ ⏭** using the SELECT button and select the track to playback by turning the ENCODER switch.

(6) Press the  button again to pause.

Press the  button to stop.

## 2. REPEAT



Press the  button to change the repeat mode.

- (1) REPEAT 1: Playback the file selected repeatedly.
- (2) REPEAT GROUP: Playback the GROUP selected repeatedly.
- (3) REPEAT ALL: Playback the disc, USB, or a memory disc repeatedly.
- (4) OFF mode: Playback the disc without repeats and then stops.

## 3. INSTANT PLAY

Memory the frequently used tracks up to 10 tracks in the memory discs to 10 instant play buttons and play the preset track directly by pressing the INSTANT PLAY button.



※ In CD or USB function, the Instant PLAY function can not be used.

### 1) Instant Program

- (1) Select the MEMORY DISK function using the SELECT button.

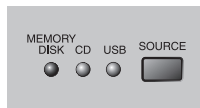

- (2) Press the  button.

- (3) Select the memory disc which has music files to preset.



- (4) Select  using the SELECT button.









- (5) Turning the  switch to select the music file to preset.
- (6) Press the wanted INSTANT PLAY button for about 2 seconds.
- (7) If the music file is saved in the selected INSTANT PLAY button then the INSTANT PLAY button is lit.
- (8) Press the ESC button to stop the INSTANT program.

### 2) Instant Play

Press the INSTANT PLAY button to play.  
After playback the track, playback stops.

### 3) Delete INSTANT PLAY setting

- (1) Press the  button.
- (2) Turning the  switch to select "DELETE INSTANT" menu and then press the  button.
- (3) Select the INSTANT PLAY button to delete and then press the  button.
- (4) Press the  button when "DELETE?" is displayed on the window.  
The led of the INSTANT PLAY button which is selected to delete is off.
- (5) To delete all the INSTANT PLAY buttons, then select the "ALL" menu using the  switch then Press the  button.

#### [NOTE]

1. If you delete the file which is memorized in a memory disc, all the files preset in the INSTANT PLAY buttons which are in the same memory disc with the deleted file are deleted.
2. In CD or USB function, the Instant Program button or the Instant Play function can not be used.

### 4. AUTO PLAY





AUTO Play is the function to preset the source (CD, USB or Memory disc) to playback and to playback the preset source when the power of the CD-6208 is turned on.  
Playback starts from the first track of the selected source.

#### 1) AUTO PLAY setting



To set the AUTO PLAY function, set the AUTO PLAY switch to ON position.

#### 2) Set the AUTO PLAY source

- (1) Press the  button.
- (2) Turn the  switch to select the AUTO PLAY menu.  
and then press the  button.
- (3) Select the source (CD, USB, DISK 1~DISK 6) to preset and then press the  button.

**[NOTE]** When the Auto Play switch is in off position, CD function is the default function when the power is turned on. The window displays the total tracks and the unit is in stop mode.  
If no disc, then the window displays "NO DISC".



## 5. RECORDING

CD-6208 can memory the music files in CD or USB to the internal memory.

### 1) CD Reaping

Music files in a CD can be saved to the memory discs (1 ~ 6) in MP3 format.

(1) Press the  button, then the REC button is lit in red. The window displays "CD → REC"

(2) Turn the  switch or press the wanted memory disc number to select the memory disc from 1 to 6 to memory the music in CD disc.

**If no input, then recording function will be stopped after 7 seconds since the REC button is pressed.**

(3) Press the  button.

Press the  button again when the window displays "DELETE DISK?" to start recording.

Recording will start after initialization of the memory disc.

The window displays "INIT".

(4) The window displays the recording status as below.

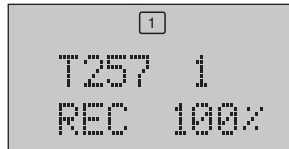

"T257" means the total files in CD. "1" means the recording file.

"REC 100%" means memory remains.

(5) To stop recording, press the  button long.

If  button is pressed during recording, the file in recording will be deleted.

(6) The memory disc is played after recording.

### [NOTE]

1. Be sure that the files in the memory disc before recording are deleted when recording starts.
2. During recording, there are no analog and digital outputs.
3. When error happens during recording, the error track is skipped so that the error track is not recorded.
4. The files in CD-DA will be converted to mp3 files which sampling frequency is 44.1kHz and the bit rate is 192kbps.
5. The mp3 files in CD will be copied to the internal memory disc as it is.
6. CD-6208 can play the MP3 file which has 44.1kHz sampling frequency and 64kbps~320kbps bit rates. CD-6208 can play the WMA file which has 44.1kHz sampling frequency and 64kbps~320kbps bit rates, or 48kHz sampling frequency and 64kbps~192kbps bit rates.
7. The memory disc 1 to 5 has 1Gbyte memory and the memory disc 6 has 3 Gbyte memory.
8. It may be a little difference between the displayed memory size and the practical memory size.

## 2) USB copying

The music files in USB (MP3 or WMA) can be copied to the internal memory.

(1) Press the  button to copy the files in the USB.

The  button is lit in red and the window displays "CD -> REC".

Press the  button again then the window displays "USB -> REC".

(2) Turn the  switch or press the memory disc select button to select the wanted memory disc from 1 to 6 to memory the music files in the USB.

**If no input, then recording function will be stopped after 7 seconds since the REC button is pressed.**

(3) Press the  button.

Press the  button again when the window displays "DELETE DISK?" to start recording.

Recording will start after initialization of the memory disc.

The window displays "INIT".

(4) The window displays the recording status as below.

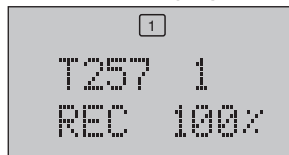

"T257" means the total files in the USB. "1" means the recording file.

"REC 100%" means memory remains.

(5) To stop recording, press the  button long.

If  button is pressed during recording, the file in recording will be deleted.

(6) The memory disc is played after recording.

### [NOTE]





1. Be sure that the files in the memory disc before recording are deleted when recording starts.
2. CD-6208 can play the MP3 file which has 44.1kHz sampling frequency and 64kbps~320kbps bit rates.  
CD-6208 can play the WMA file which has 44.1kHz sampling frequency and 64kbps~320kbps bit rates, or 48kHz sampling frequency and 64kbps~192kbps bit rates.
3. When copying music files in a USB to the internal memory disc, the track number of the copied files from the USB to the internal memory is numbered according to the order that files are copied to the USB. If playback sequence is needed, then copy files to the USB which has no MP3 files in the order of wanted playback sequence respectively.
4. Maximum 32GB USB memory can be used.

## 6. DELETE







Delete function is used to delete the files in the memory discs.

1) Delete all the memory discs.









(1) Press the  button.

- (2) Press the  button to select the DELETE MDISK menu.
- (3) Turn the  switch to select DISK FORMAT menu and press the  button.
- (4) Press  button again when "OK?" is displayed on the window.  
All the memory discs are deleted.

## 2) Delete all the files in a memory disc

- (1) Press the  button.
- (2) Press the  button to select the DELETE MDISK menu.
- (3) Turn the  switch to select a memory disc to delete and press the  button.
- (4) Press the  button to select the ALL menu.
- (5) Press  button again when "ALL?" is displayed on the window.  
All the files in the memory disc are deleted.

## 3) Delete a file in a memory disc

- (1) Press the  button.
- (2) Press the  button to select the DELETE MDISK menu.
- (3) Turn the  switch to select a memory disc which has the file to delete and press the  button.
- (4) Turn the  switch to select the TRACK menu and press the  button.
- (5) Turn the  switch to select the track to delete and press the  button.
- (6) Press  button again when "DELETE?" is displayed on the window.  
The selected file in the memory disc is deleted.

## 7. CUE

Press the CUE button and select a track, then the point where music begins (not where the track begins) on the track is located to and enters pause mode.

Press the  button to start playback at exactly that point.

When the CUE button is pressed during playback, then it goes to the point where music begins on the track and enters into pause mode.

Press the  button to start playback.

## 8. PITCH

Pitch can control the playback speed rapidly or slowly for your preference. Pitch setting is not released even if turn the power off and on.

### 1) PITCH ON

(1) Press the  button.

(2) Turn the  switch to select the PITCH menu and press the  button.

(3) Press the  button when the window displays "PITCH ON".  
The PITCH LED is lit.

(4) Press the PITCH "+" or "-" button to set the pitch.  
The window displays +/-10 steps.  
Pitch varies  $\pm 15\%$ .

### 2) PITCH OFF

(1) Press the  button.

(2) Turn the  switch to select the PITCH menu and press the  button.

(3) Press the  button when the window displays "PITCH OFF".  
The window displays "OK".  
The PITCH LED is off.

## 9. EJECT

Press EJECT button to eject a disc.

## 10. DISPLAY MODE

Press the  button to select the time mode which is the played time or the remaining time.

### [NOTE]

1. The maximum display of CD-DA is 99 tracks.
2. The maximum display of MP3 CD is 499 files.
3. The maximum display of a USB is 499 files.
4. The maximum files of a memory disc are 300 files.  
After recording 300 files, then the window displays "REC FULL" and recording stops.
5. When copying mp3 files in a CD to the internal memory disc, if error occurs, then the file is skipped.

## 11. CAUTION

### ※ CAUTION

1. **DO NOT TURN OFF THE POWER** during formatting the memory disc, it causes the memory disc fault. If the memory disc failure happens, then "ERROR 2" or "READING ERROR" displays. Consult with the service personal.
2. If you delete a file which is in a memory disc, all the files preset in the INSTANT PLAY button which are in the same memory disc with the deleted file are deleted.
3. During copying, there are no analog and digital audio outputs.
4. When reaping a CD-DA to a memory disc, if error occurs, then the file is skipped. Reaping speed is about 1.3 times. During reaping, there are no analog and digital audio outputs.
5. If error happens on a track or a track is not compatible format, then "PLAY ERROR" displays on the window and the track is skipped.
6. When error happens during recording, the error track is skipped so that the error track is not recorded.
7. When copying music files in a USB to the internal memory disc, the track number of the copied files from the USB to the internal memory is numbered according to the order that files are copied to the USB. If playback sequence is needed, then copy files to the USB which has no MP3 files in the order of wanted playback sequence respectively.
8. Maximum 32GB USB memory can be used.
9. The memory disc 1 to 5 has 1Gbyte memory and the memory disc 6 has 3 Gbyte memory.
10. **DO NOT INSERT** a CD of 8 cm size into the slot.

# Block Diagram

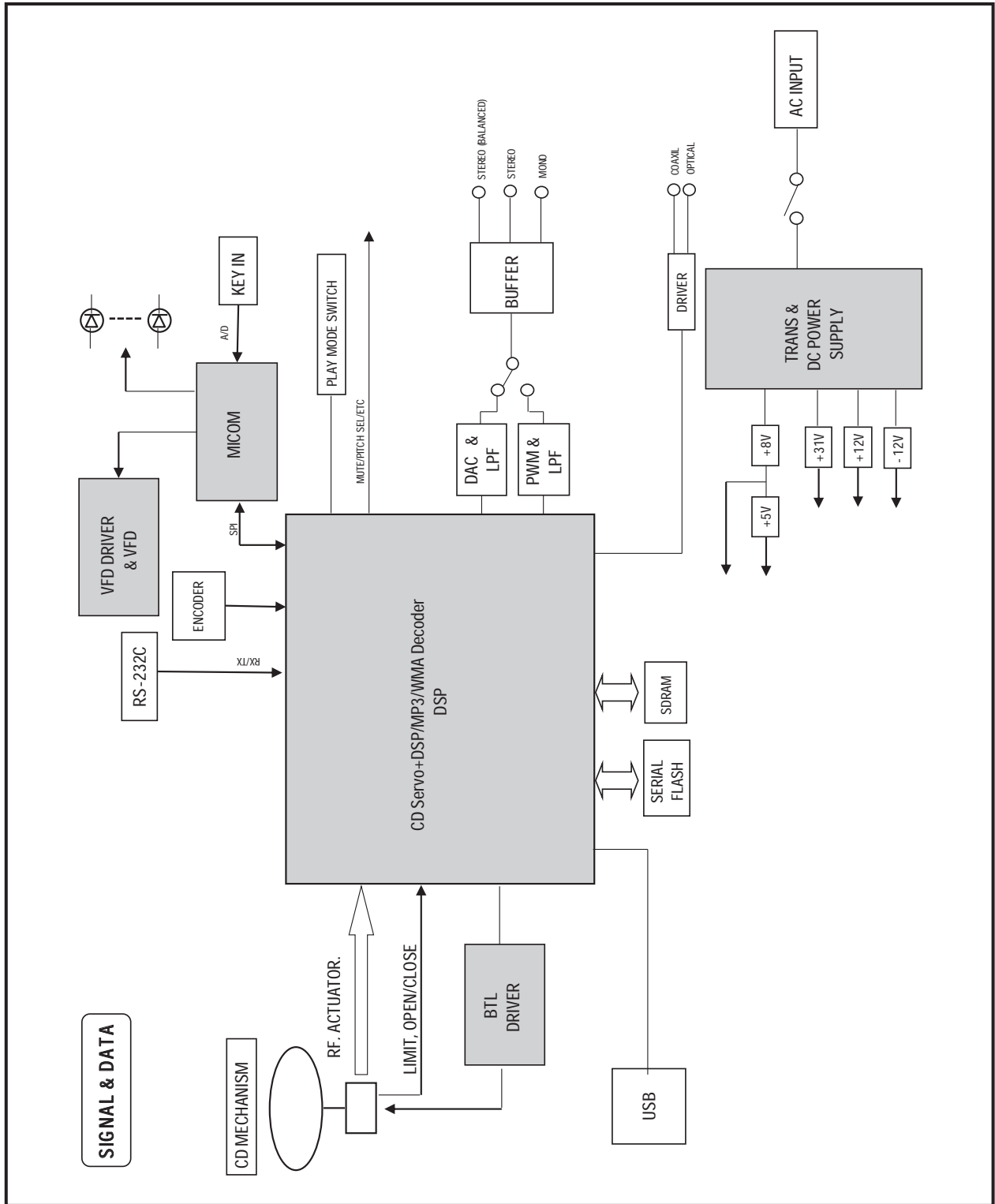

## Specifications

	CD-6208
Disc	12cm (4.7 inch) CD, CD-R, CD-RW
Formats	Audio CD (CD-DA), MP3, WMA
Number of channels	3 channels (L,R,Mono)
Analog Output Connectors	RCA: L / R, XLR: L / R / Mono
Analog Output Level (Max)	+8 dBu (2Vrms)
Frequency Response (20Hz ~ 20kHz) – CD, Pitch off	+0.5/-1 dB
T.H.D. (20kHz LPF) – CD, Pitch off	Less than 0.003% (Nor), 0.007% (Lim)
S/N (20kHz LPF, A-WTD) – CD, Pitch off	Better than 100dB (Nor), 95dB (Lim)
Channel separation (1kHz, +8dBu, 20kHz LPF) – CD, Pitch off	Better than 90dB (Nor), 80dB (Lim)
Optical Output	S/PDIF
Coaxial Output (RCA)	S/PDIF
Operation Temperature	-10°C ~ +40°C
Power Source	USA/CANADA 120VAC, 60Hz UK/Europe 230VAC, 50Hz Australia 240VAC, 50Hz
Power Consumption	27W
Weight (SET)	5.3kg / 11.7lb
Dimensions (SET)	482(W)x88(H)x280(D) mm/19(W)x3.5(H)x11(D) in

\* Specifications and design are subject to change without notice.

※ DIMENSIONS

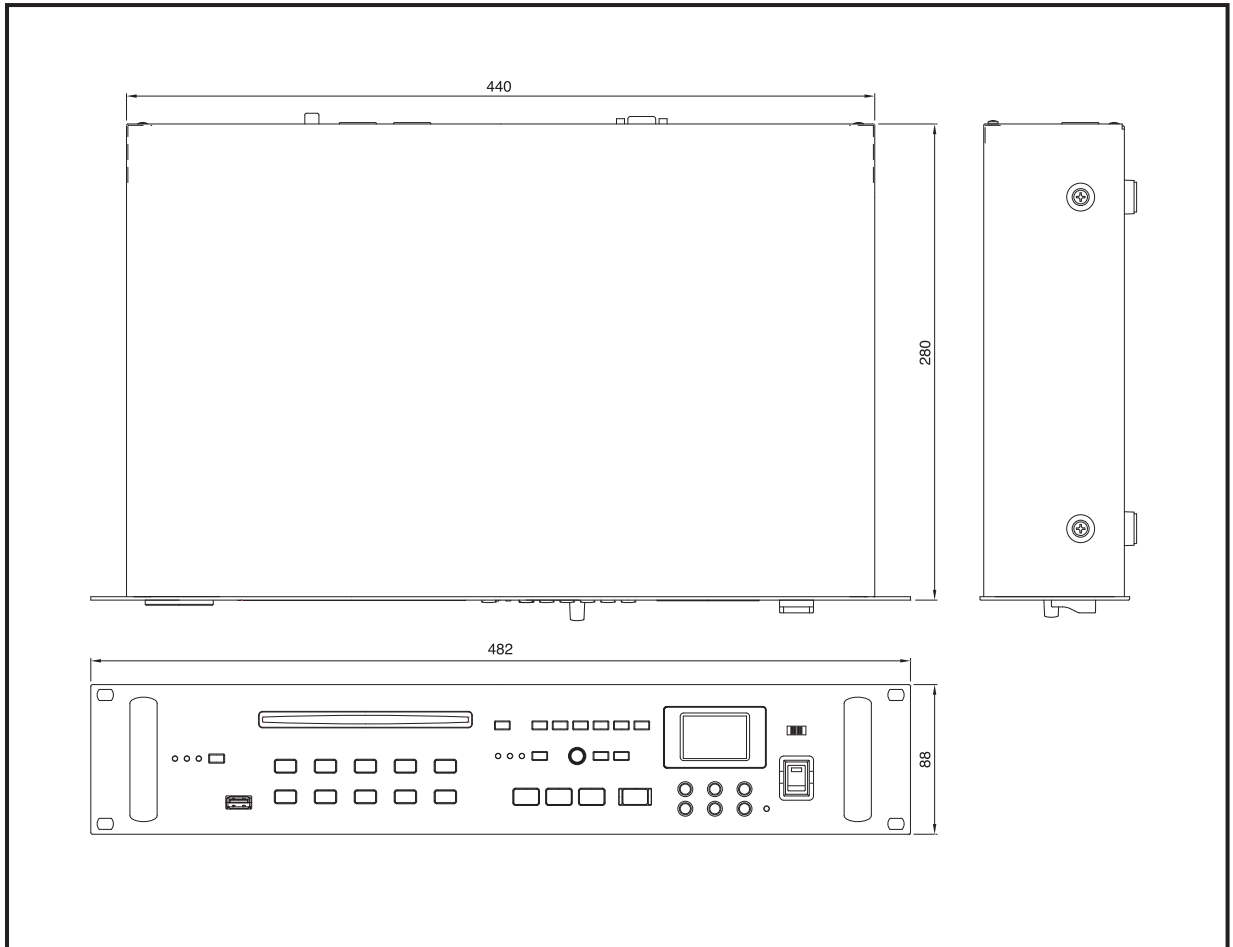



## Service

### Procedures

Take steps to insure the problem is not related to operator error or other products within the system. Information provided in the troubleshooting portion of this manual may help with this process. Once it is certain that the problem is related to the product contact your warranty provider as described in the warranty section of this manual.

### Schematic

A Schematic is available by contacting your warranty provider.

### Parts List

A Parts List is available by contacting your warranty provider.

## Variations and Options

### Variations

Products supplied through legitimate sources are compatible with local AC power requirements.

### Options

No optional items are available for this product.

## Warranty

Warranty terms and conditions vary by country and may not be the same for all products. Terms and conditions of warranty for a given product may be determined first by locating the appropriate country which the product was purchased in, then by locating the product type.

To obtain specific warranty information and available service locations contact Inter-M directly or the authorized Inter-M Distributor for your specific country or region.





# interM



Inter-M, Ltd. (Korea) began operations in 1983.

Since then, Inter-M has grown to become one of the largest manufacturers of professional audio and commercial sound electronics equipment in the world.

Inter-M has gained worldwide recognition for its own branded products, as well as private label manufacturing of electronics sold under other names (OEM).

The company is no longer just a Korean company, but rather a global company that is truly international in scope, with factories and offices in Korea and China, and sales and marketing operations located in Japan, Europe, and the U.S.A.

With more than 850 employees around the globe, Inter-M is well-poised for further growth and expansion.

**Inter-M Americas, Inc.**

13875 Artesia Blvd. Cerritos, CA 90703 USA  
TEL : +1-562-921-0313, FAX : +1-562-921-0370  
Home Page : <http://www.inter-m.net>, E-mail : [info@inter-m.net](mailto:info@inter-m.net)

**Inter-M Corporation**

Seoul OFFICE: 653-5 BANGHAK-DONG, DOBONG-KU, SEOUL, KOREA  
TEL : +82-2-2289-8140~8, FAX : +82-2-2289-8149  
Home Page : <http://www.inter-m.com>, E-mail : [overseas@inter-m.com](mailto:overseas@inter-m.com)

**MADE IN KOREA**  
April 2012 130171