



## PUV-2010TXWP/RXWP

100m HDBaseT™ 2.0 Wall Plate Transmitter (4K, HDCP2.2,  
PoH, LAN, OAR, USB)

**OPERATION MANUAL**



## **DISCLAIMERS**

The information in this manual has been carefully checked and is believed to be accurate. CYP (UK) Ltd assumes no responsibility for any infringements of patents or other rights of third parties which may result from its use.

CYP (UK) Ltd assumes no responsibility for any inaccuracies that may be contained in this document. CYP (UK) Ltd also makes no commitment to update or to keep current the information contained in this document.

CYP (UK) Ltd reserves the right to make improvements to this document and/or product at any time and without notice.

## **COPYRIGHT NOTICE**

No part of this document may be reproduced, transmitted, transcribed, stored in a retrieval system, or any of its part translated into any language or computer file, in any form or by any means—electronic, mechanical, magnetic, optical, chemical, manual, or otherwise—without express written permission and consent from CYP (UK) Ltd.

© Copyright 2011 by CYP (UK) Ltd.

All Rights Reserved.

Version 1.1 August 2011

## **TRADEMARK ACKNOWLEDGMENTS**

All products or service names mentioned in this document may be trademarks of the companies with which they are associated.

## SAFETY PRECAUTIONS

Please read all instructions before attempting to unpack, install or operate this equipment and before connecting the power supply.

Please keep the following in mind as you unpack and install this equipment:

- Always follow basic safety precautions to reduce the risk of fire, electrical shock and injury to persons.
- To prevent fire or shock hazard, do not expose the unit to rain, moisture or install this product near water.
- Never spill liquid of any kind on or into this product.
- Never push an object of any kind into this product through any openings or empty slots in the unit, as you may damage parts inside the unit.
- Do not attach the power supply cabling to building surfaces.
- Use only the supplied power supply unit (PSU). Do not use the PSU if it is damaged.
- Do not allow anything to rest on the power cabling or allow any weight to be placed upon it or any person walk on it.
- To protect the unit from overheating, do not block any vents or openings in the unit housing that provide ventilation and allow for sufficient space for air to circulate around the unit.

## REVISION HISTORY

VERSION NO.	DATE	SUMMARY OF CHANGE
v1.00	XX/XX/XXXX	First release

# CONTENTS

## UPDATE CONTENTS







## 1. INTRODUCTION

The PUV-2010TX Wall Plate Transmitter enables transmission of video resolutions up to 4K UHD, along with HD audio, 2-Way IR, RS-232, PoH (Power over HDBaseT), LAN, and USB data signals up to 100m. Utilising the latest HDBaseT™ 2.0 technology, this solution provides advanced signal management and dedicated audio pathways to ensure reliable results in the most demanding of installation environments. In addition to the full 5-Play convergence, this device also incorporates OAR (Optical Audio Return) and ARC (Audio Return Channel) functions which enable audio from a compatible display to be routed back from the receiver unit to the transmitter. All audio, video, control, and power are transmitted simultaneously over a single CAT6a/7 cable up to 100m.







This system also allows the connection of any USB host, enabling a USB connection to 2 USB ports, giving the PU-2010RX Receiver the ability to act like a USB hub.

This wall plate variant of the PUV-2010TX transmitter enables seamless integration into a standard UK double-gang back box.

## 2. APPLICATIONS

-  48V PoH from Transmitter (PSE) to Receiver (PD)
-  Household entertainment extending and control
-  Lecture room display and control
-  Showroom display and control
-  Meeting room presentation and control
-  Classroom display and control

## 3. PACKAGE CONTENTS

-  1×HDMI/Audio over CAT5e/6/7 Transmitter
-  1×HDMI/Audio over CAT5e/6/7 Receiver
-  1×IR Blaster
-  ×IR Extender
-  1×48V/0.83 A DC Power Adaptor
-  1×Power Cable
-  1×Operation Manual

## 4. SYSTEM REQUIREMENTS

Input source equipment such as DVD/Blu-ray player, host PC/Laptop and HDMI equipped output display (TV or monitor) with amplifier or active speakers.

## 5. FEATURES

- /// Supports full HDBaseT™ 2.0 specification signals can be received up to a maximum distance of 100m over CAT6a/7
- /// HDCP 2.2, HDMI and DVI compatible
- /// HDBaseT 5-Play™ convergence: High-Definition video and audio, 100BaseT Ethernet, PoH (Power over HDBaseT) and control (Bi-Directional IR & RS-232 pass through)
- /// Supported resolutions VGA~WUXGA, 480i~1080p, 4K UHD@24/25/30Hz (RGB 4:4:4 & YUV 4:2:2), 4K UHD@ 60Hz (YUV 4:2:0), 4K/2K@24/25/30Hz (RGB 4:4:4 & YUV 4:2:2) and 4K/2K@ 60Hz (YUV 4:2:0) dependent upon the output display's EDID settings
- /// 4K/2K & 4K UHD signals can be transmitted up to 70m via CAT5e/6 and 100m via CAT6a/7
- /// Supports pass-through of HD audio formats: LPCM 2/5.1/7.1CH, Dolby Digital 2/5.1CH, Dolby Digital Plus, Dolby TrueHD, Dolby Atmos and DTS-HD Master Audio
- /// Optical audio return (OAR)
- /// Supports optical sampling rate up to 48kHz
- /// Audio return channel (ARC)
- /// Dedicated channel for analogue stereo audio transmission from the transmitter to a compatible receiver
- /// USB Data Serving from Transmitter (single USB) to Receiver (2x USB)
- /// Fits in standard UK double-gang back-box

## 6. OPERATION CONTROLS AND FUNCTIONS

### 6.1 Transmitter Front Panel

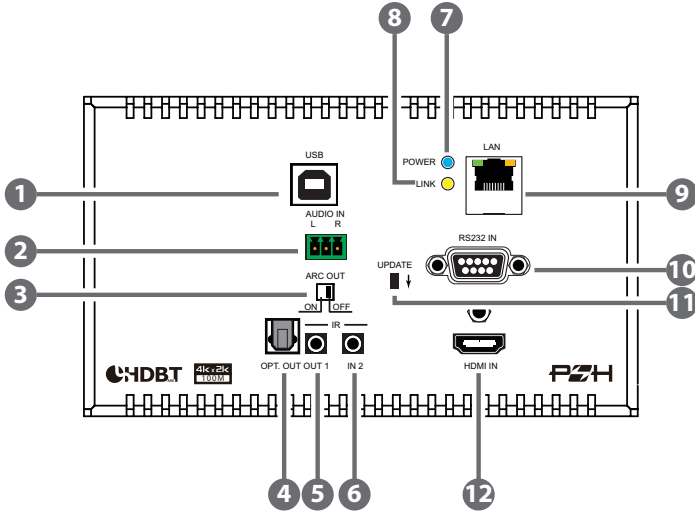

- 1 USB:** Connect from PC or Laptop for data transmit to or control from the Receiver's USB slots.
- 2 AUDIO IN L/R:** Connect with audio source equipment such as PC or CD player with 3-pin Relay cable for audio signal sending to Receiver's AUDIO OUT L/R.
- 3 ARC OUT OFF/ON SWITCH:** Switch this dip switch to allows ARC (Audio Return Channel) function to be activate or not. Switch to OFF to disable ARC function. Switch to ON allows Receiver's HDMI output or Optical in audio to be routed back and output to both HDMI IN and Optical OUT on the transmitter side.

*Note: When ARC switch to ON, depending on the connected devices of the HDMI OUT & Optical in from Receiver and the connected device of the HDMI In & Optical Out at the Transmitter the audio format and behavior may be varied, the ARC input/output transmission distance may be varied too, it is suggested to use cable within 2 metres long to ensure the best audio quality.*

- 4 OPT. OUT:** Connect to speaker for audio signal output from Receiver's OPTICAL IN or ARC from HDMI out.



- 5 **IR OUT 1:** Connect to the supplied IR Blaster Cable for IR signal transmission. Place the IR Blaster in direct line-of-sight of the equipment to be controlled.
- 6 **IR IN 2:** Connect to the supplied IR Extender cable for IR signal reception. Ensure that remote being used is within the direct line-of-sight of the IR Extender.
- 7 **POWER LED:** When the device is connected with power supply the LED will illuminate.
- 8 **LINK LED:** This LED will illuminate to indicate a successful connection between Transmitter and Receiver, when it blink irregularly it represent the link error or when not illuminate it means no link with Receiver.
- 9 **LAN:** Connect to internet or network service system to this slot or to the LAN port slot of the Receiver side for a total sharing rate of 100Mbps withing the link. The yellow LED will illuminate to represent the link with Transmitter is steady, when it blink irregularly it represent the link error or when not illuminate it means no link with Receiver. The green LED will illuminate to represent the Ethernet speed is with 100Mbit/s.
- 10 **RS-232 IN:** Connect to a PC or Laptop D-Sub 9-pin female cable for the transmission of RS-232 commands.
- 11 **UPDATE:** This is reserved for firmware update use only. Switch this deep switch down for firmware update use, under normal operation, leave the switch up. Update procedure may be done from the same RS-232 port for both Transmitter and Receiver.
- 12 **HDMI IN:** Connect to HDMI source equipment such as a DVD or Blu-ray player.

*Note: When ARC switch to ON, this slot will be receiving signal from Receiver and will not be able to send signal out to Receiver.*

## 6.2 Transmitter Rear Panel

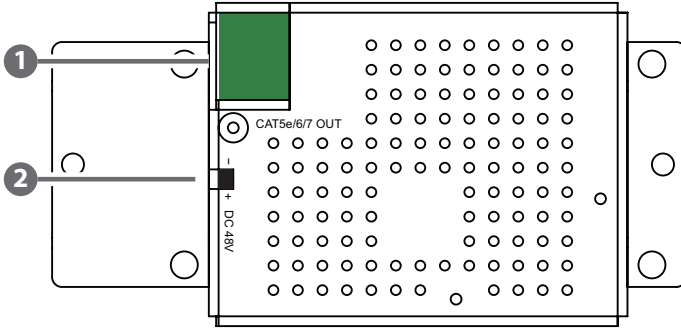

- 1 CAT5e/6/7 OUT:** Connect to the Receiver unit with CAT5e/6/7 cable for transmission of all data signals.
- 2 DC 48V:** Plug the 48V DC power supply into the unit and connect the adaptor to an AC outlet.

## 6.3 Receiver Front Panel

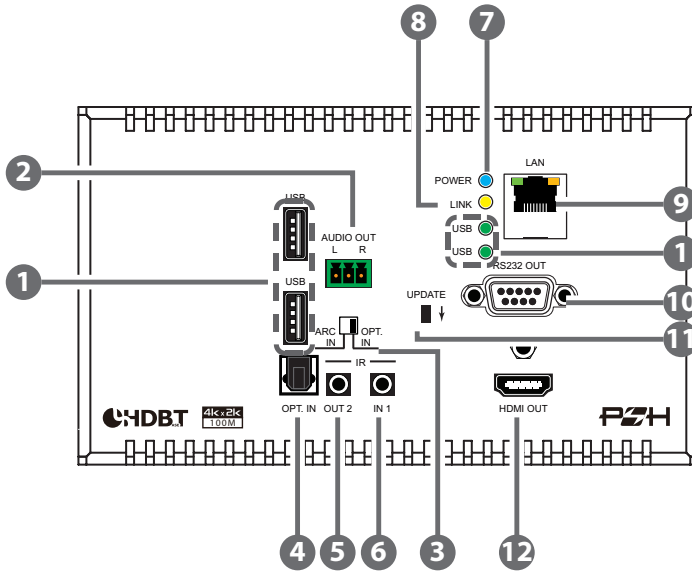

- 1 USB & LED:** Connect to USB peripheral devices such as printer, keyboard, flash driver or ...etc. for data receiving or sending back to Transmitter and the LED will be illuminated.
- 2 AUDIO OUT L/R:** Connect to speaker with RCA input for audio signal output.
- 3 ARC IN/OPT. IN SWITCH:** Switch this dip switch to select ARC (Audio Return Channel) from HDMI Out/Optical In. The audio will be routed back and output to both HDMI IN and Optical OUT on the transmitter side.  
*Note: When ARC switch to ON, depending on the connected devices of the HDMI OUT & Optical in, the ARC input/output transmission distance may be varied. It is suggested to use cable within 2 metres long to ensure the best audio quality.*
- 4 OPT. IN:** Connect to audio source equipment such as DVD or Blu-ray player for audio signal sending to Transmitter's Optical Out and HDMI IN.
- 5 IR OUT 2:** Connect to the supplied IR Blaster cable for IR signal transmission. Place the IR Blaster in direct line-of-sight of the equipment to be controlled.

- ⑥ **IR IN 1:** Connect to the supplied IR Extender cable for IR signal reception. Ensure that remote being used is within the direct line-of-sight of the IR Extender.
- ⑦ **POWER LED:** This LED will illuminate when the device is connected from Transmitter with PoH power supply.
- ⑧ **LINK LED:** This LED will illuminate to indicate a successful connection between Transmitter and Receiver, when it blink irregularly it represent the link error or when not illuminate it means no link with Transmitter.
- ⑨ **LAN:** Connect to internet or network service system to this slot or to the LAN port slot of the Transmitter side for a total sharing rate of 100Mbps withing the link. The yellow LED will illuminate to represent the link with Transmitter is steady, when it blink irregularly it represent the link error or when not illuminate it means no link with Receiver. The green LED will illuminate to represent the Ethernet speed is with 100Mbit/s.
- ⑩ **RS-232 OUT:** Connect to the device that is to be controlled via D-Sub 9-pin male cable by RS-232 commands.
- ⑪ **UPDATE:** This is reserved for firmware update use only. Switch this deep switch down for firmware update use, under normal operation, leave the switch up. Update procedure may be done from the same RS-232 port for both Transmitter and Receiver.
- ⑫ **HDMI OUT:** Connect to HDMI source equipment such as a DVD or Blu-ray player.

*Note: When ARC IN is selected, depending on the connected device the audio behavior, format & cable distance may be varied. It is suggested to use cable within 2 metres long to ensure the best audio quality.*

## 6.4 Receiver Rear Panel

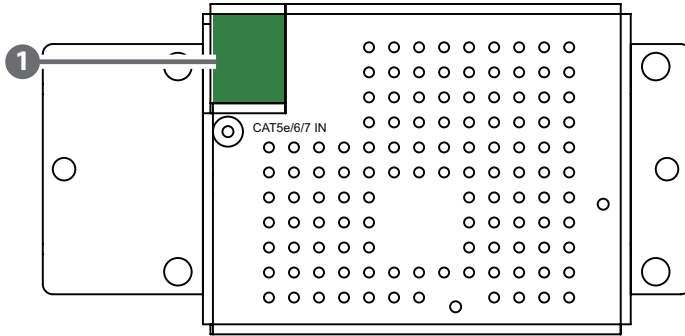

- 1 CAT5e/6/7 IN:** Connect to the Transmitter unit with CAT5e/6/7 cable for transmission of all data signals.

## 6.5 IR Cable Pin Assignments

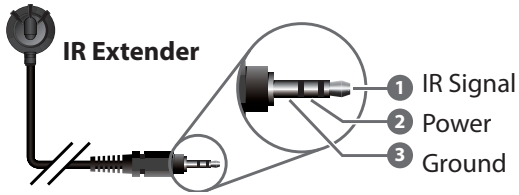
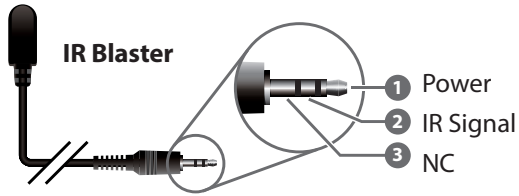

## 6.6 D-Sub 9-Pin Assignment

Pin	Define TX / RX
1	N/C
2	TxD/RxD
3	RxD/TxD
4	N/C
5	GND
6	N/C
7	N/C
8	N/C
9	N/C
9	NC

# 7. CONNECTION DIAGRAM

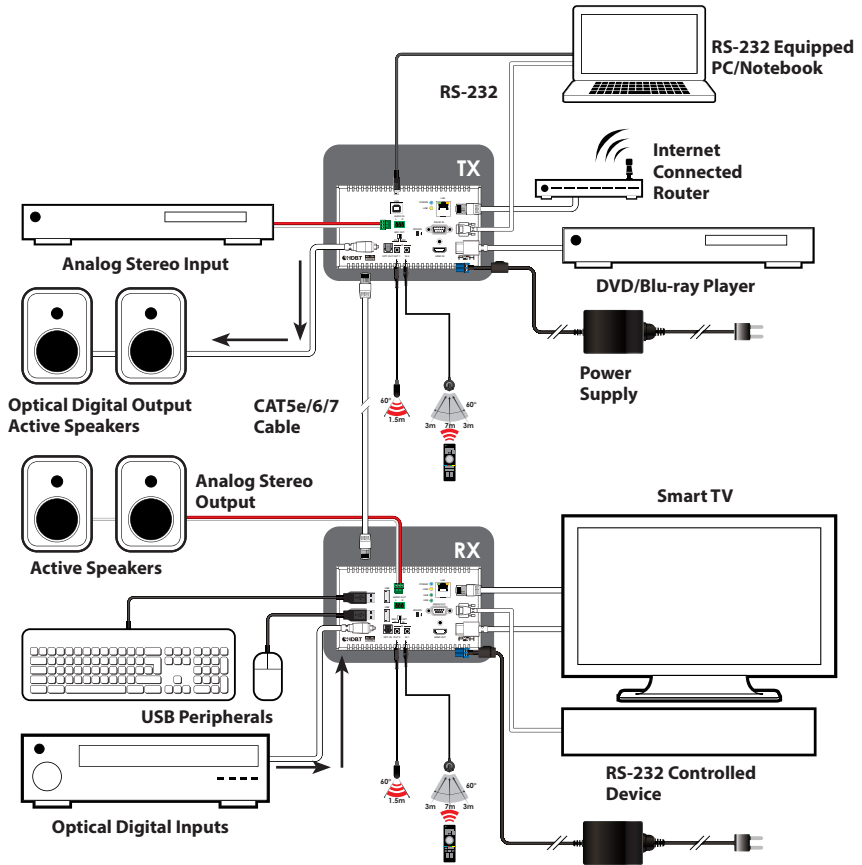

## 8. SPECIFICATIONS

### 8.1 Technical Specification

<b>Video Bandwidth</b>	340 MHz/10.2 Gbps
<b><i>Transmitter</i></b>	
<b>Input Ports</b>	1×HDMI, 1×USB, 1×L/R (Terminal Block), 1×LAN, 1×IR Extender, 1×RS-232
<b>Output Ports</b>	1×CAT5e/6/7, 1×Optical, 1×IR Blaster
<b><i>Receiver</i></b>	
<b>Input Ports</b>	1×CAT5e/6/7, 1×Optical, 1×IR Extender
<b>Output Ports</b>	1×HDMI, 2×USB, 1×L/R (Terminal Block), 1×LAN, 1×IR Blaster, 1×RS-232
<b>IR Frequency</b>	30~50 kHz
<b>Baud Rate</b>	Up to 115200 bps
<b>Power Supply</b>	48V/0.83 A DC (US/EU standards, CE/FCC/UL certified)
<b>ESD Protection</b>	Human Body model: ± 8kV (air-gap discharge) ± 4kV (contact discharge)
<b>Dimensions</b>	156mm (W)× 90 mm (D)×36 mm (H)/TX & RX Jacks Excluded  156mm (W)× 90 mm (D)×40 mm (H)/TX & RX Jacks Included
<b>Weight</b>	266 g/TX, 264 g/RX
<b>Chassis Material</b>	Metal
<b>Silkscreen Colour</b>	White
<b>Operating Temperature</b>	0°C~40°C/32°F~104°F
<b>Storage temperature</b>	-20°C~60°C/-4°F~140°F
<b>Relative Humidity</b>	20~90% RH (no condensation)
<b>Power Consumption</b>	21.34W



## 8.2 CAT5e/6/7 Cable Specification

Cable Type	Range	Pixel Clock Rate	Video Data Rate	Supported Video Formats
<b>CAT5e/6/7</b>	100 m	≤225 MHz	≤5.3 Gbps (HD Video)	Up to 1080p@60 Hz, 36-bit, 3D (data rates lower than 5.3 Gbps or below 225 MHz TMDS clock).
<b>CAT6/7</b>	100 m	>225 MHz	>5.3 Gbps (Ultra HD Video)	4K2K@30 Hz video formats
<b>CAT5e</b>	90 m			

## 8.3 HDBT Specification

HDBT FEATURE	SUPPORT
<b>ARC</b>	Yes
<b>Video &amp; Audio</b>	Yes
<b>IR</b>	Yes
<b>RS-232</b>	Yes
<b>Send Power to TX</b>	No
<b>Send Power to RX</b>	Yes

## 8.4 Supported Resolutions

Resolution	Input	Output
640×480@60	✓	✓
720×480@60	✓	✓
720×576p@50	✓	✓
800×600@60	✓	✓
1024×768@60	✓	✓
1280×720@50	✓	✓
1280×720p@50	✓	✓
1280×720p@60	✓	✓
1280×1024@60	✓	✓
1360×768@60	✓	✓
1600×1200@60	✓	✓
1920×1080i@50	✓	✓
1920×1080i@60	✓	✓
1920×1080p@24	✓	✓
1920×1080p@25	✓	✓
1920×1080p@30	✓	✓
1920×1080p@50	✓	✓
1920×1080p@60	✓	✓
1920×1200@60 (RB)	✓	✓
3840×2160@24	✓	✓
3840×2160@25	✓	✓
3840×2160@30	✓	✓
3840×2160@60	✓	✓
3840×2160@60 (YUV420)	✓	✓
4096×2160@24	✓	✓

## 9. ACRONYMS

ACRONYM	COMPLETE TERM
<b>ARC</b>	Audio Return Channel
<b>OPT</b>	Optical



Bringing  
technology  
to life.

CIE-Group Ltd 3 Widdowson Close Blenheim Ind Est Bulwell Nottingham NG6 8WB England  
T: +44(0)115 9770075 F: +44(0)115 9770081 E: [info@cie-group.com](mailto:info@cie-group.com) W: [www.cie-group.com](http://www.cie-group.com)

Registered in England No. 2761780

 @ciegroup  CIE-Group  [facebook.com/ciegroup](https://facebook.com/ciegroup)



FS 31532