

# Operation Manual

## RM-05A Remote Amp with Zone Selector

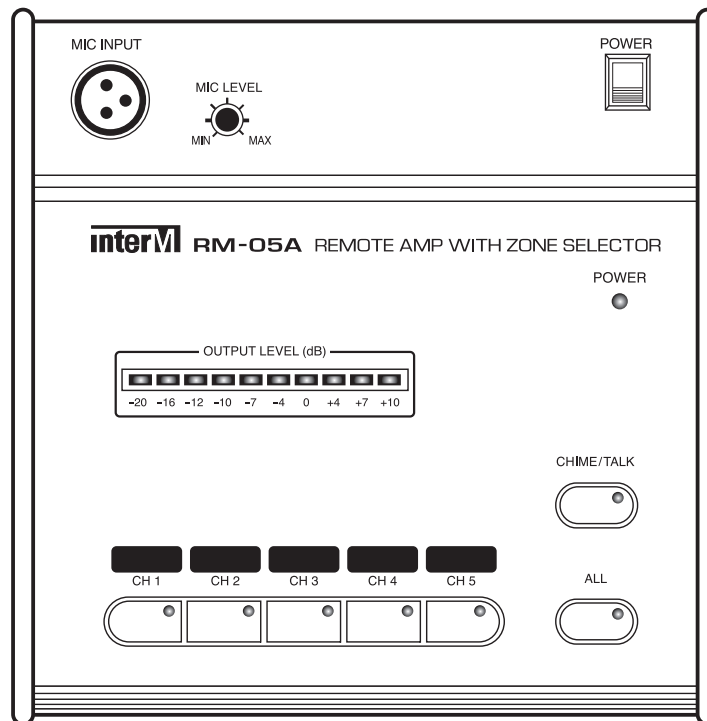

**interM**

# Contents

<b>Welcome</b>	
Warning.....	1
<b>Installation</b>	
Environment.....	2
Important Safety Instructions.....	2
<b>Features.....</b>	<b>3</b>
Accessories.....	3
<b>Operating Procedure .....</b>	<b>3</b>
<b>Front Panel .....</b>	<b>4</b>
<b>Rear Panel .....</b>	<b>6</b>
<b>Applications .....</b>	<b>7</b>
<b>Block Diagram .....</b>	<b>8</b>
<b>Specifications .....</b>	<b>9</b>
<b>Service</b>	
Procedures.....	10
Schematic.....	10
Parts List .....	10
<b>Variations and Options .....</b>	<b>10</b>
<b>Warranty .....</b>	<b>10</b>

# Welcome

A personal welcome to you from the management and employees of Inter-M

All of the co-workers here at Inter-M are dedicated to providing excellent products with inherently good value, and we are delighted you have purchased one of our products.

We sincerely trust this product will provide years of satisfactory service, but if anything is not to your complete satisfaction, we will endeavor to make things right.

Welcome to Inter-M, and thank you for becoming part of our worldwide extended family!

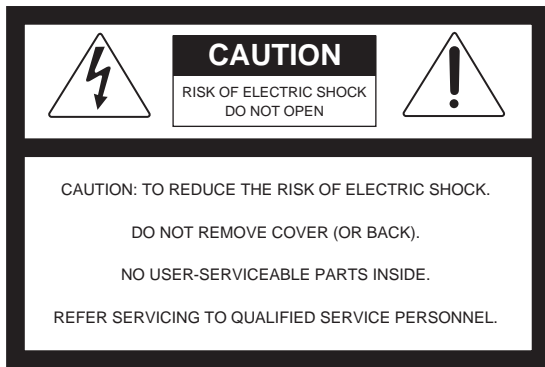

## WARNING

To prevent fire or shock hazard, do not expose the unit to rain or moisture.

\*Do not install this equipment in a confined space such as a book case or similar unit.

\*The apparatus shall not be exposed to dripping or splashing and no objects filled with liquids, such as vases, shall be placed on the apparatus.

\*Worded: "WARNING FOR YOUR PROTECTION PLEASE READ THE FOLLOWING-WATER AND MOISTURE: Unit should not be used near water(e.g. near a bathtub, washbowl, kitchen sink, laundry tub, in a wet basement, or near a swimming pool, etc). Care should be taken so that objects do not fall and liquids are not spilled into the enclosure through openings."

### Service Instructions

\*Worded: "Caution: These servicing instructions are for use by qualified service personnel only. To reduce the risk of electric shock, do not perform any servicing other than that contained in the operating instructions unless you are qualified to do so."

\*Location: Instruction Manual.

**NOTE :** This equipment has been tested and found to comply with the limits for a Class A digital device, pursuant to Part 15 of the FCC Rules. These limits are designed to provide reasonable protection against harmful interference when the equipment is operated in a commercial environment. This equipment generates, uses, and can radiate radio frequency energy and, if not installed and used in accordance with the instruction manual, may cause harmful interference to radio communications. Operation of this equipment in a residential area is likely to cause harmful interference in which case the user will be required to correct the interference at his own expense.



This symbol is intended to alert the user to the presence of uninsulated "dangerous voltage" within the product's enclosure that may be of sufficient magnitude to constitute a risk of electric shock to persons.



This symbol is intended to alert the user to the presence of important operation and maintenance (servicing) instructions in the literature accompanying the appliance.

Caution: To prevent electric shock do not use this (polarized) plug with an extension cord, receptacle or other outlet unless the blades can be fully inserted to prevent blade exposure.

Attentions: Pour prévenir les chocs électriques ne pas utiliser cette fiche polarisée avec un prolongateur, une prise de courant ou une autre sortie de courant, sauf si les lames peuvent être insérées à fond sans en laisser aucune partie à découvert.

\* It can be heated up if you use this product in closed box or ill-ventilated place.

## Installation

### Environment

Never place this product in an environment which could alter its performance or reduce its service life. Such environments usually include high levels of heat, dust, moisture, and vibration.

## IMPORTANT SAFETY INSTRUCTIONS

1. Read these instructions.
2. Keep these instructions.
3. Heed all warnings.
4. Follow all instructions.
5. Do not use this apparatus near water.
6. Clean only with dry cloth.
7. Do not block any ventilation openings. Install in accordance with the manufacturer's instructions.
8. Do not install near any heat sources such as radiators, heat registers, stoves, or other apparatus (including amplifiers) that produce heat.
9. Do not defeat the safety purpose of the polarized or grounding-type plug. A polarized plug has two blades with one wider than the other. A grounding type plug has two blades and a third grounding prong. The wide blade or the third prong are provided for your safety. If the provided plug does not fit into your outlet, consult an electrician for replacement of the obsolete outlet.
10. Protect the power cord from being walked on or pinched particularly at plugs, convenience receptacles, and the point where they exit from the apparatus.
11. Only use attachments/accessories specified by the manufacturer.
12. Use only with the cart, stand, tripod, bracket, or table specified by the manufacturer, or sold with the apparatus. When a cart is used, use caution when moving the cart/apparatus combination to avoid injury from tip-over.
13. Unplug this apparatus during lightning storms or when unused for long periods of time.
14. Refer all servicing to qualified service personnel. Servicing is required when the apparatus has been damaged in any way, such as power-supply cord or plug is damaged, liquid has been spilled or objects have fallen into the apparatus, the apparatus has been exposed to rain or moisture, does not operate normally, or has been dropped.



## Features

- **SPEAKER LINE CONTROL**  
Speaker zone of PAM-240A/360A, PCT-610/620 can be controlled by RM-05A.
- **CHIME AND TALK FUNCTION**  
There are 4 levels of chime in PAM-240A/360A, PCT-610/620 which can be triggered by Chime/Talk Switch, and after chime is finished, announcement from mic will be made while pushing switch button.
- **OUTPUT LEVEL METER**  
10 segments LED display on the front panel indicates signal output level of RM-05A at real time.
- **MIC BROADCASTING**  
Highly sensitive condenser type Mic is used for clear broadcasting.
- **EXCLUSIVE USE FOR PAM-240A/360A, PCT-610/620**  
RM-05A is the dedicated remote control amplifier for PAM series, so it only can be used with PAM-240A/360A, PCT-610/620.
- **MUTE FUNCTION FOR CHIME OUT**  
Chime melody can be muted by simple operation.

## Operating Procedure

1. Ensure the Power Switch is selected to the on position.
2. Select which channel or combination of channels you wish to address by selecting the required CH1-CH5 buttons.
3. To address all the channels select the all button.
4. The CH1-CH5 and All buttons are latching type, when selected a LED lights to show the selection you have made.
5. When you are ready to make your address, press the Talk Switch and speak into the microphone.
6. Pressing the Talk Switch will also activate the Pre Announcement Chime facility (for set up details see instructions later in this manual)
7. The microphone output level can be adjusted using the level control located next to the gooseneck microphone connector.
8. After completion of the address the selected CH1-CH5 or All buttons must be deselected clearing the microphone ready for the next selection.

## Front Panel

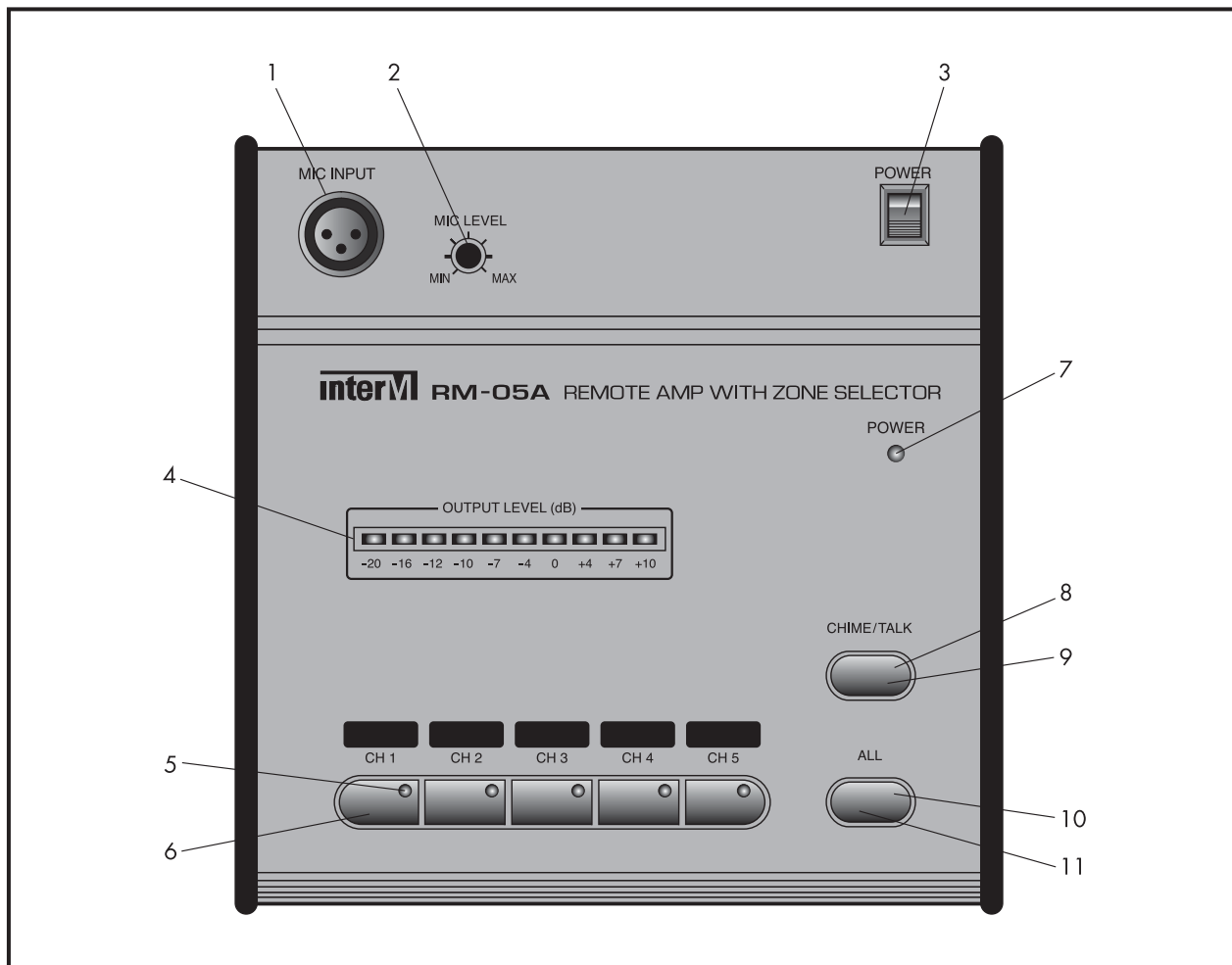

### 1. MICROPHONE INPUT CONNECTOR

The CMC-01 gooseneck is connected via the XLR connector.

### 2. MICROPHONE LEVEL CONTROL

Turn clockwise to increase and counter clockwise to decrease the microphone volume level.

### 3. POWER SWITCH

Switches ON and OFF the microphone unit.

### 4. OUTPUT LEVEL METER

Indicates the signal output level between -20dB and +10dB.

### 5. ZONE/CHANNEL LED INDICATOR

Visual indication of the selected channel.

**6. ZONE/CHANNEL SELECTION SWITCH**

Allows any combination of CH1-CH5 to be selected for broadcast of voice messages.

**7. POWER LED**

Indicates that power is present at the microphone unit.

**8. CHIME/TALK SWITCH LED INDICATOR**

Indicates when the chime talk switch is pressed.

**9. CHIME/TALK SWITCH**

Used to broadcast to the selected channels. A pre- announcement chime option is available by adjustment of the internal jumper settings.

\* If you want to mute chime, please change the position of jumper as below description.

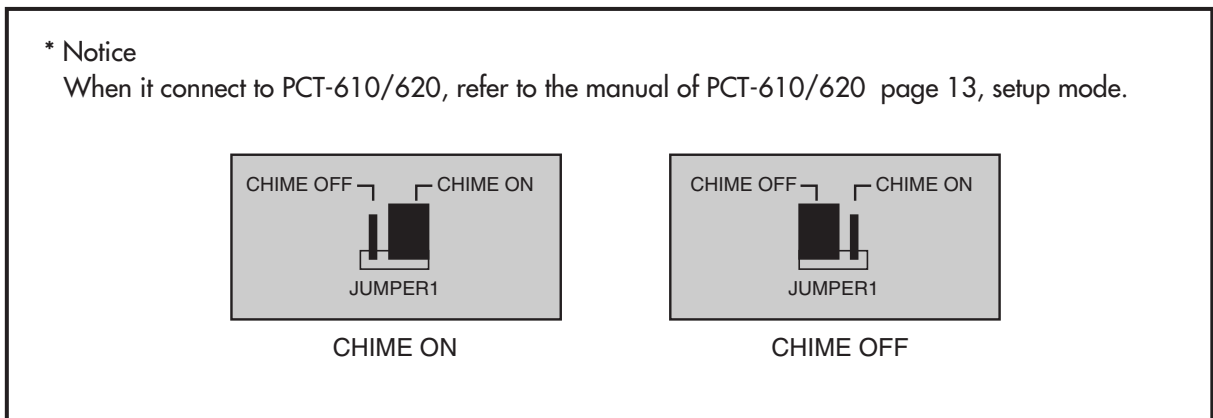

**10. ALL ZONE LED INDICATOR**

Visual indication that all channels have been selected for broadcast.

**11. ALL ZONE SELECTION SWITCH**

Selects all channels for broadcast.

## Rear Panel

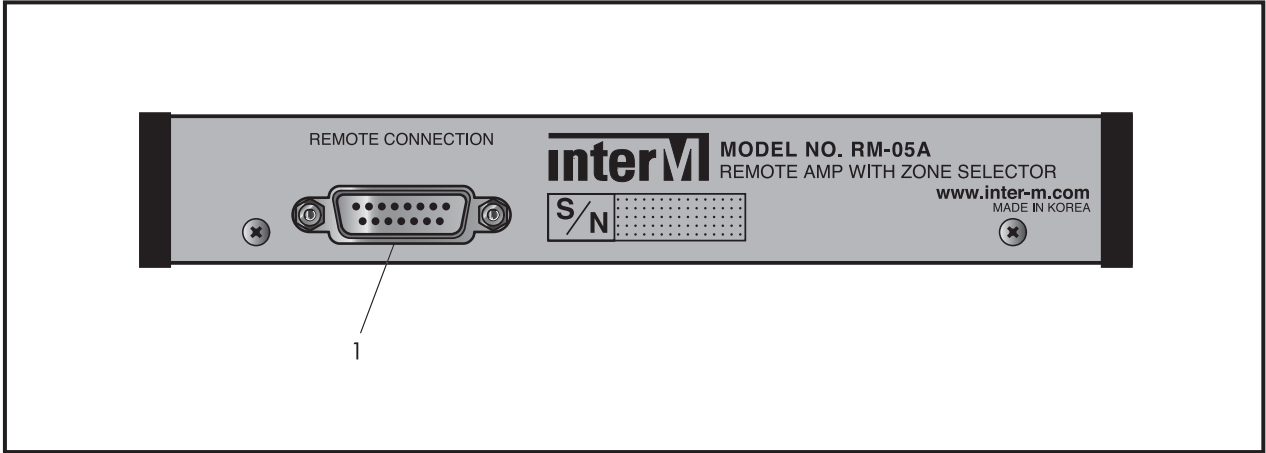

### 1. REMOTE CONNECTION CABLE CONNECTOR

Used to connect the RM-05A to the host amplifier PAM-240A/360A, PCT-610/620.

\* Refer to pin number as below

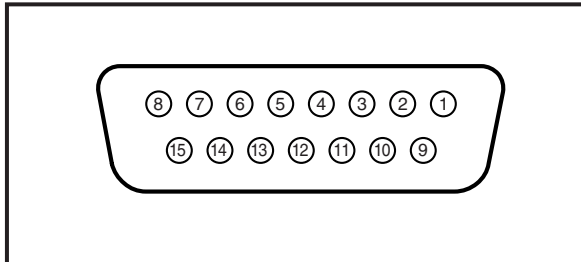

You can use conveniently Remote Control (Speaker zone can be selected and chime can be operated) through the D-SUB jack (15 pin)

Pin 1 : Remote amplifier input signal hot (+)	Pin 10 : DC +24V
Pin 2 : Remote amplifier input signal cold (-)	Pin 11 : Remote chime
Pin 3 : Signal ground	Pin 12 : NC
Pin 4 : Remote control 1 (SP1)	Pin 13 : NC
Pin 5 : Remote control 2 (SP2)	Pin 14 : NC
Pin 6 : Remote control 3 (SP3)	Pin 15 : NC
Pin 7 : Remote control 4 (SP4)	
Pin 8 : Remote control 5 (SP5)	
Pin 9 : Remote control ground	

\* Remote cable length must be used within 3 meter (cable 3m)



# Applications

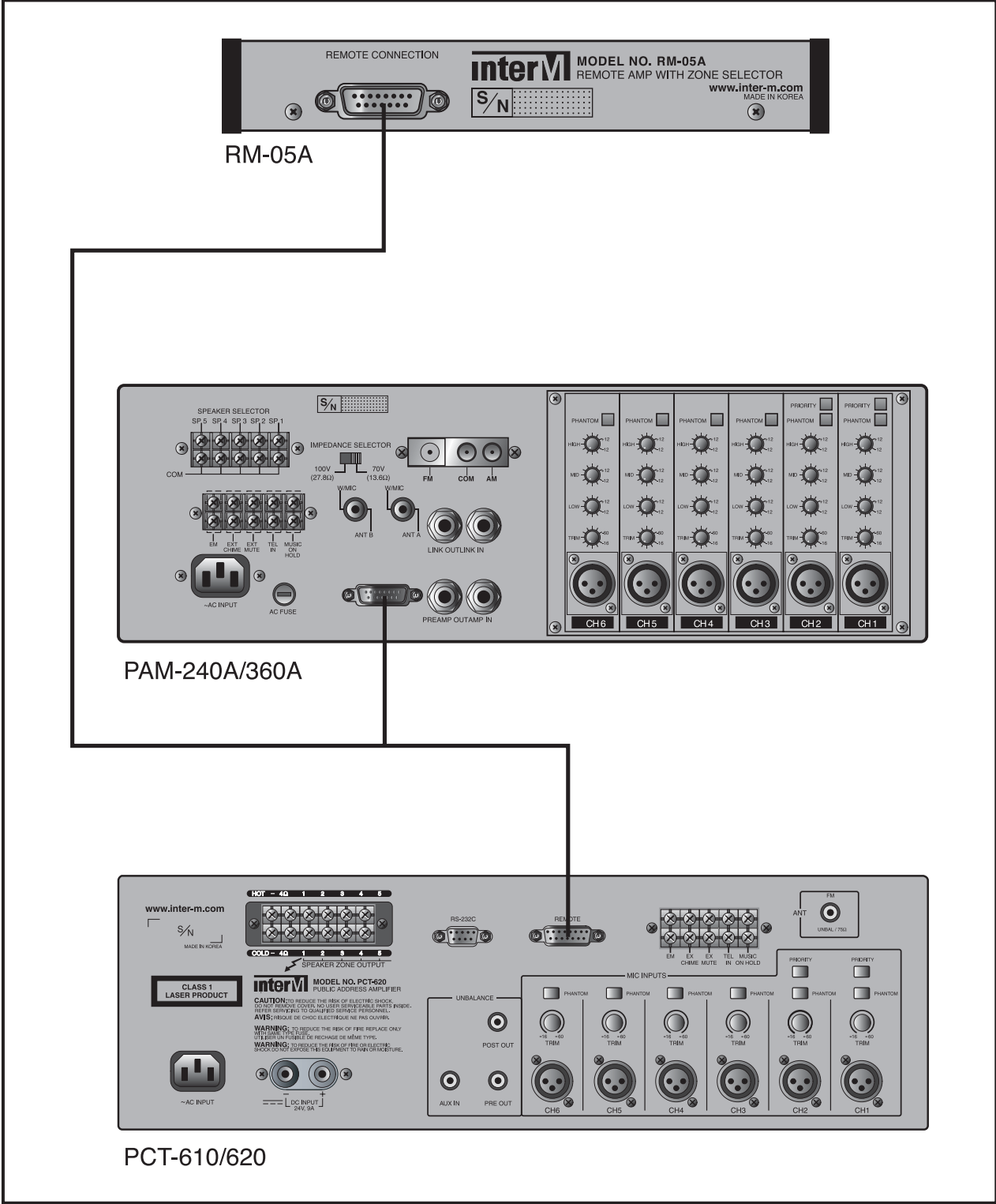

# Block Diagram

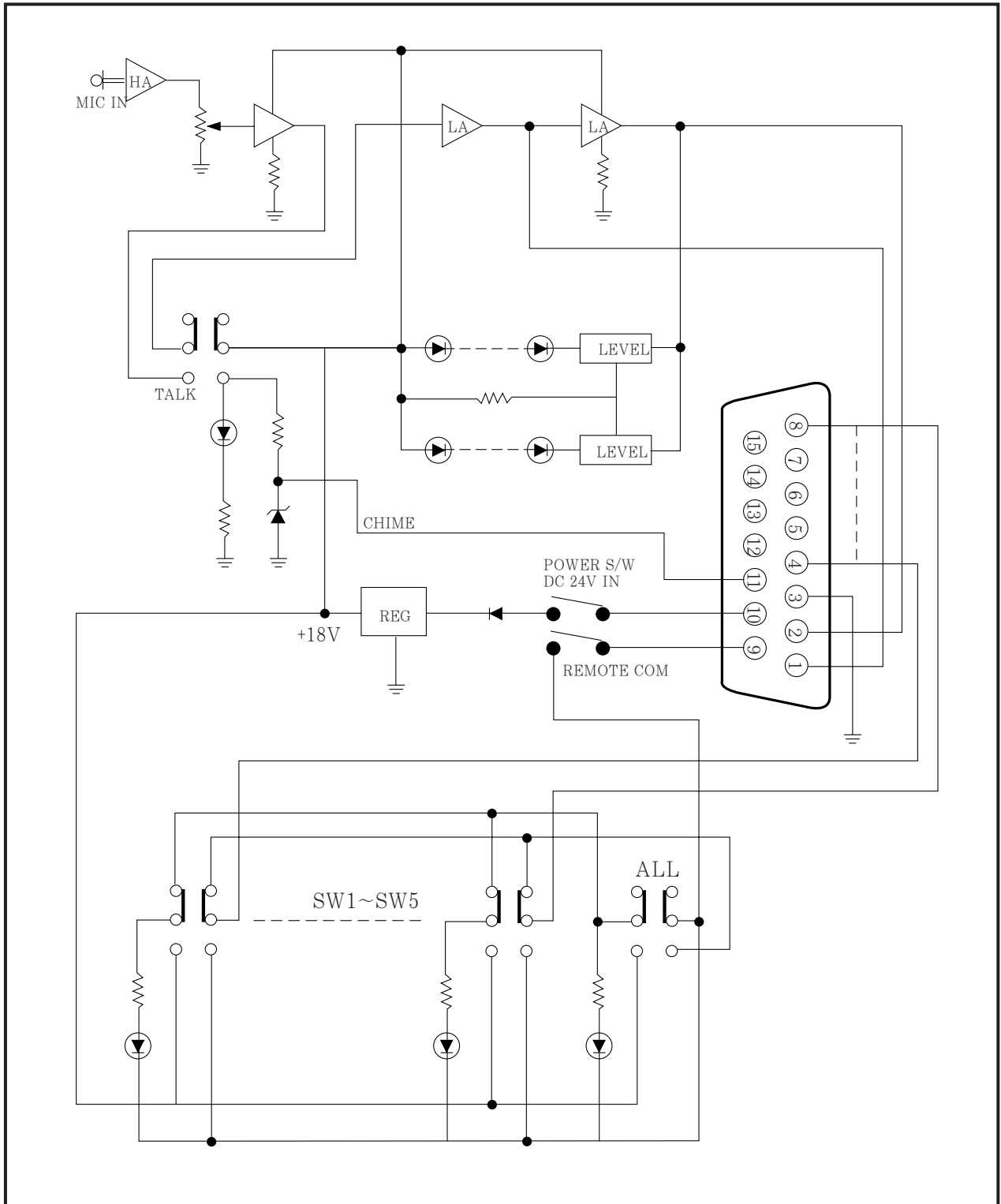

# Specifications

**- ELECTRICAL**

Output Level/Impedance .....	1V±200mV(max gain)/600Ω, BAL
MIC Input Sensitivity/Impedance.....	0.8mV/±0.3mV/600Ω, BAL
Frequency Response.....	120Hz~18kHz, ±3dB
THD .....	Less than 0.7%
S/N.....	Better than 55dB
Speaker Control Terminal & Switch .....	5CH

**- GENERAL**

Power Source.....	DC 24V (used by D-Sub connector)
Weight.....	800g/1.8lb
Dimensions .....	194(W) x 60(H) x 205(D)mm/7.6(W) x 2.4(H) x 8.1 (D)in

**- ACCESSORIES**

D-Sub Connector.....	15pin, 3m
----------------------	-----------

**- MIC (CMC-01) Specifications**

Type.....	Condenser Microphone
Polar Pattern .....	Unidirectional
Frequency Response.....	50Hz~16kHz
Impedance.....	Max 680Ω
Sensitivity (0dB=1V/0/.1Pa at 1kHz) .....	-45dB±4dB(0dB=1V/0.1Pa at 1kHz)
Sensitivity Reduction.....	Within -3dB at 1.0V
Current Consumption .....	Max 0.5mA
S/N Ratio .....	More than 55dB
Standard Power Supply.....	DC 1.5V
Weight Goose Neck.....	97g±10/0.2lb

\* Specifications and design subject to change without notice.

## Service

### Procedures

Ensure the problem is not related to operator error, or system devices that are external to this unit. Information provided in the troubleshooting portion of this manual may help with this process. Once it is certain that the problem is related to the product contact your warranty provider as described in the warranty section of this manual.

### Schematic

A Schematic is available by contacting your warranty provider.

### Parts List

A Parts List is available by contacting your warranty provider.

## Variations and Options

### Variations

Products supplied through legitimate sources are compatible with local DC power requirements.

### Options

No optional items are available for this product.

## Warranty

Warranty terms and conditions vary by country and may not be the same for all products. Terms and conditions of warranty for a given product may be determined first by locating the appropriate country which the product was purchased in, then by locating the product type.

To obtain specific warranty information and available service locations contact Inter-M directly(in Korea or the USA) or the authorized Inter-M Distributor for your specific country or region.



NOTE

---

**interM**